

Phase Noise Guide

Agilent Technologies PSA and ESA-E Series Spectrum Analyzers Option 226



**Manufacturing Part Number: E4440-90233
Supersedes: E4440-90233, January 2004**

Printed in USA

January 2006

© Copyright 2000 - 2006 Agilent Technologies, Inc.

Notice

The information contained in this document is subject to change without notice.

Agilent Technologies makes no warranty of any kind with regard to this material, including but not limited to, the implied warranties of merchantability and fitness for a particular purpose. Agilent Technologies shall not be liable for errors contained herein or for incidental or consequential damages in connection with the furnishing, performance, or use of this material.

Where to Find the Latest Information

Documentation is updated periodically. For the latest information about Agilent ESA and PSA Spectrum Analyzers, including firmware upgrades, software upgrades, application information, and product information, please visit the Internet URLs listed below.

<http://www.agilent.com/find/esa> (for ESA spectrum analyzers)

<http://www.agilent.com/find/psa> (for PSA spectrum analyzers)

1. Getting Started	
Introduction	16
Specifications	16
Licensing the Phase Noise Personality	17
Installing the Phase Noise Personality on ESA Analyzers	18
Removing the Phase Noise Personality on ESA Analyzers	19
Installing the Phase Noise Personality on PSA Analyzers	20
Available Measurement Personality Options	20
Loading an Optional Measurement Personality	22
Installing a License Key	23
Viewing a License Key	23
Using the Delete License Key	24
Starting the Phase Noise Personality	25
2. Using the Phase Noise Personality	
Using the Phase Noise Personality	28
Functionality	29
Log Plot Measurements	29
Spot Frequency Measurements	31
Smoothing, Averaging and Filtering	31
Signal Tracking	31
Measurement Considerations	33
Slowly Drifting Signals	33
System Noise Floor	33
Display Accuracy at 10 dB Per Division	33
Cancellation and Log Plot Measurements	34
Background Information	34
Log Plot Cancellation	35
Creating a DANL Floor Reference Trace	37
Example Measurement -	
Using a DANL Reference for Cancellation	37
Creating a Signal Phase Noise Reference Trace	40
Example Measurement -	
Using a Phase Noise Measurement for Cancellation	40
Saving Traces	42
Restoring Traces	42
Additional Information	44
3. Menu Maps	
What You Will Find in This Chapter	46
Menus	47
Amplitude Menu - Log Plot	47
Amplitude Menu - Spot Frequency	48
BW/Avg Menu	49
Det/Demod Menus	50
Display Menus - Log Plot	51
Display Menus - Monitor Spectrum	52
Display Menus - Spot Frequency	53

Contents

File Menu	54
Frequency/Channel Menu	55
Input Output Menu	56
Installer Menu (ESA Series of Analyzers Only)	57
Marker Menu - Log Plot	58
Measure Menu	59
Meas Setup Menus - Log Plot	60
Meas Setup Menus - Monitor Spectrum	61
Meas Setup Menus - Spot Frequency	62
Mode Menu	63
Mode Setup Menus	64
Span (X Scale) Menu - Log Plot	65
Span (X Scale) Menu - Monitor Spectrum	66
Span (X Scale) Menu - Spot Frequency	67
Sweep Menu - Log Plot	68
Sweep Menu - Spot Frequency	69
Trigger Menu	70
View and Trace Menus - Log Plot	71
View and Trace Menus - Monitor Spectrum	72
View and Trace Menus - Spot Frequency	73

4. Front-Panel Key Reference

Key Descriptions and Locations	76
AMPLITUDE Y Scale	77
Det/Demod	79
Display	80
FREQUENCY Channel	81
Input/Output	83
Marker	84
Meas Setup	87
MEASURE	90
MODE	91
Mode Setup	92
Preset	93
SPAN X Scale	94
Sweep Menu	95
Trace/View	96

5. Language Reference

CALCulate Subsystem	100
CALCulate:LPLot Subsystem	101
CALCulate:MARKers Subsystem	103
CONFigure Subsystem	106
Configure the Selected Measurement	106
Configure Query	106
DISPlay Subsystem	107
Set the Display Line	107
Control the Display Line	107

FETCh Subsystem	108
Fetch the Current Measurement Results	108
FORMat Subsystem	109
Measurement Results format	109
INITiate Subsystem.	110
Take New Data Acquisition for Selected Measurement	110
INSTRument Subsystem	111
Select Application by Number	111
Select Application	112
MEASure Group of Commands	115
CONFigure, FETCh, MEASure, READ Interactions	115
Phase Noise Log Plot Measurement	119
Monitor Spectrum	121
Phase Noise Spot Frequency Measurement	122
MMEMory Subsystem	123
Load a Log Plot Reference Trace from Disk	123
Store a Log Plot Reference Trace to Disk	124
READ Subsystem	125
Initiate and Read Measurement Data	125
SENSE Subsystem.	126
Display Average Noise Level—Measurement Method	127
Default Reset	127
Frequency Commands	128
Phase Noise Log Plot Measurements	132
Monitor Band/Channel Measurement	139
RF Power Commands	143
Spot Frequency Measurements	144
6. If You Have A Problem	
Agilent Customer Assistance	152

Contents

List of Commands

:CALCulate:LPLot:DECade:TABLE[:STATe] OFF ON 0 1	101
:CALCulate:LPLot:DECade:TABLE[:STATe]?	101
:CALCulate:LPLot:MARKer:TABLE[:STATe] OFF ON 0 1	103
:CALCulate:LPLot:MARKer:TABLE[:STATe]?	103
:CALCulate:LPLot:MARKer[1] 2 3 4:MODE POSition DELTa RMSDegree RMSRadian RFM RMSJitter OFF	103
:CALCulate:LPLot:MARKer[1] 2 3 4:MODE?	103
:CALCulate:LPLot:MARKer[1] 2 3 4:TRACe <tracenum>	104
:CALCulate:LPLot:MARKer[1] 2 3 4:TRACe?	104
:CALCulate:LPLot:MARKer[1] 2 3 4:X <number>	104
:CALCulate:LPLot:MARKer[1] 2 3 4:X?	104
:CALCulate:LPLot:MARKer[1] 2 3 4:Y?	104
:CALCulate:LPLot:TRACe:COPI[A][B]	101
:CALCulate:LPLot:TRACe:SWAP[A][B]	102
:CALCulate:LPLot:TRACe[1] 2 3:MODE RAW SMOothed VIEW BLANK	101
:CALCulate:LPLot:TRACe[1] 2 3:MODE?	101
:CONFigure:<measurement>	106
:CONFigure:MONitor	121
:CONFigure?	106
:DISPlay:MONitor:WINDow:TRACe:Y:DLINe <ampl>	107
:DISPlay:MONitor:WINDow:TRACe:Y:DLINe:STATe OFF ON 0 1	107
:DISPlay:MONitor:WINDow:TRACe:Y:DLINe:STATe?	107
:DISPlay:MONitor:WINDow:TRACe:Y:DLINe?	107
:FETCh:<measurement>[n]?	108
:FETCh:LPLot[n]?	119
:FETCh:MONitor[n]	121
:FETCh:SFRequency[n]?	122
:FORMat:MEASure[:DATA] ASCii REAL32	109
:FORMat:MEASure[:DATA]?	109
:INITiate:<measurement>	110
:INSTrument:NSElect <integer>	111

List of Commands

:INSTrument:NSElect?	111
:INSTrument[:SElect] 'SA' 'GSM' 'CDMA' 'PNOISE' 'BLUETOOTH' 'EDGE'	112
:INSTrument[:SElect] SA PNOISE BASIC CDMA CDMA2K EDGE GSM NADC PDC WCD- MA	112
:INSTrument[:SElect]?	112
:MEASure:LPLot[n]?	119
:MEASure:MONitor[n]	121
:MEASure:SFRequency[n]?	122
:MMEMory:LPLot:LOAD:TRACe <tracenum>,<filename>	123
:MMEMory:LPLot:LOAD:TRACe <tracenum>,<filename>	123
:MMEMory:LPLot:STORe:TRACe <tracenum>,<filename>	124
:MMEMory:LPLot:STORe:TRACe <tracenum>,<filename>	124
:READ:<measurement>[n]?	125
:READ:LPLot[n]?	119
:READ:MONitor[n]	121
:READ:SFRequency[n]?	122
[:SENSe]:DANL:METHod ATTenuator REMoval	127
[:SENSe]:DANL:METHod?	127
[:SENSe]:DEFaults	127
[:SENSe]:FREQuency:CARRier <freq>	128
[:SENSe]:FREQuency:CARRier:SEARch	128
[:SENSe]:FREQuency:CARRier:SEARch:AUTO ON OFF 1 0	129
[:SENSe]:FREQuency:CARRier:SEARch:AUTO?	129
[:SENSe]:FREQuency:CARRier:SEARch:SPAN <freq>	129
[:SENSe]:FREQuency:CARRier:SEARch:SPAN?	129
[:SENSe]:FREQuency:CARRier:TRACk:DSPan <value>	130
[:SENSe]:FREQuency:CARRier:TRACk:DSPan?	130
[:SENSe]:FREQuency:CARRier:TRACk:INTerval <value>	130
[:SENSe]:FREQuency:CARRier:TRACk:INTerval?	130
[:SENSe]:FREQuency:CARRier:TRACk:METHod INTerval TOLerance BOTH	131
[:SENSe]:FREQuency:CARRier:TRACk:METHod?	131

List of Commands

[:SENSe]:FREQuency:CARRier:TRACk:TOLerance <value>	131
[:SENSe]:FREQuency:CARRier:TRACk:TOLerance?	131
[:SENSe]:FREQuency:CARRier:TRACk[:STATe] OFF ON 1 0	129
[:SENSe]:FREQuency:CARRier:TRACk[:STATe]?	129
[:SENSe]:FREQuency:CARRier?	128
[:SENSe]:LPLot:AVERage[:STATe] ON OFF 1 0	132
[:SENSe]:LPLot:AVERage:COUNT <integer>	132
[:SENSe]:LPLot:AVERage:COUNT?	132
[:SENSe]:LPLot:AVERage:TCONtrol?	132
[:SENSe]:LPLot:AVERage[:STATe]?	132
[:SENSe]:LPLot:BANDwidth BWIDth:VIDeo:RATio <numeric>	133
[:SENSe]:LPLot:BANDwidth BWIDth:VIDeo:RATio?	133
[:SENSe]:LPLot:BANDwidth BWIDth:VIDeo?	133
[:SENSe]:LPLot:BANDwidth BWIDth[:RESolution]?	133
[:SENSe]:LPLot:CANCellation:DELTA <dB>	133
[:SENSe]:LPLot:CANCellation:DELTA?	133
[:SENSe]:LPLot:CANCellation:TRACe <tracenum>	134
[:SENSe]:LPLot:CANCellation:TRACe?	134
[:SENSe]:LPLot:CANCellation[:STATe] OFF ON 0 1	134
[:SENSe]:LPLot:CANCellation[:STATe]?	134
[:SENSe]:LPLot:DETEctor[:FUNCTion]?	135
[:SENSe]:LPLot:DIAG:GRAPh:Y:REFerence <level>	135
[:SENSe]:LPLot:DIAG:GRAPh:Y:REFerence?	135
[:SENSe]:LPLot:FILTeriNg:NONE LITtle MEDium MAXimum	135
[:SENSe]:LPLot:FREQuency:OFFSet:STARt <freq>	135
[:SENSe]:LPLot:FREQuency:OFFSet:STARt?	135
[:SENSe]:LPLot:FREQuency:OFFSet:STOP <freq>	136
[:SENSe]:LPLot:FREQuency:OFFSet:STOP?	136
[:SENSe]:LPLot:FREQuency:SPAN:BANDwidth BWIDth[:RESolution]:RATio <numeric>	136
[:SENSe]:LPLot:FREQuency:SPAN:BANDwidth BWIDth[:RESolution]:RATio:AUTO ON OFF 1 0	137

List of Commands

[:SENSe]:LPLot:FREQuency:SPAN:BANDwidth BWIDth[:RESolution]:RATio:AUTO?	137
[:SENSe]:LPLot:FREQuency:SPAN:BANDwidth BWIDth[:RESolution]:RATio?	136
[:SENSe]:LPLot:METHod DANL PN	137
[:SENSe]:LPLot:METHod?	137
[:SENSe]:LPLot:SMOoth <percentage>	137
[:SENSe]:LPLot:SMOoth?	137
[:SENSe]:MONitor:AVERage:COUNT <integer>	139
[:SENSe]:MONitor:AVERage:COUNT?	139
[:SENSe]:MONitor:AVERage:TCONtrol EXPonential REPeat	140
[:SENSe]:MONitor:AVERage:TCONtrol?	140
[:SENSe]:MONitor:AVERage[:STATe] OFF ON 0 1	139
[:SENSe]:MONitor:AVERage[:STATe]?	139
[:SENSe]:MONitor:FREQuency:SPAN <freq>	140
[:SENSe]:MONitor:FREQuency:SPAN:FULL	141
[:SENSe]:MONitor:FREQuency:SPAN:ZERO	142
[:SENSe]:MONitor:FREQuency:SPAN?	140
[:SENSe]:MONitor:SWEep:POINts?	142
[:SENSe]:MONitor:SWEep:TIME <value>	142
[:SENSe]:MONitor:SWEep:TIME:AUTO ON OFF 1 0	143
[:SENSe]:MONitor:SWEep:TIME:AUTO?	143
[:SENSe]:MONitor:SWEep:TIME?	142
[:SENSe]:POWer[:RF]:MIXer:RANGe[:UPPer] <power>	143
[:SENSe]:POWer[:RF]:MIXer:RANGe[:UPPer]?	143
[:SENSe]:SFRequency:AVERage:COUNT <integer>	144
[:SENSe]:SFRequency:AVERage:COUNT?	144
[:SENSe]:SFRequency:AVERage:TCONtrol EXPonential REPeat	144
[:SENSe]:SFRequency:AVERage:TCONtrol?	144
[:SENSe]:SFRequency:AVERage[:STATe] ON OFF 1 0	144
[:SENSe]:SFRequency:AVERage[:STATe]?	144
[:SENSe]:SFRequency:BANDwidth BWIDth:VIDeo:AUTO?	145
[:SENSe]:SFRequency:BANDwidth BWIDth:VIDeo:RATio <numeric>	146

List of Commands

[:SENSe]:SFRequency:BANDwidth BWIDth:VIDeo:RATio?	146
[:SENSe]:SFRequency:BANDwidth BWIDth:VIDeo?	145
[:SENSe]:SFRequency:BANDwidth BWIDth[:RESolution]:AUTO?	145
[:SENSe]:SFRequency:BANDwidth BWIDth[:RESolution]?	145
[:SENSe]:SFRequency:DETEctor[:FUNctioN]?	146
[:SENSe]:SFRequency:METHod DANL PN	146
[:SENSe]:SFRequency:METHod?	146
[:SENSe]:SFRequency:PNOFrequency <freq>	147
[:SENSe]:SFRequency:PNOFrequency:AUTO ON OFF 1 0	147
[:SENSe]:SFRequency:PNOFrequency:AUTO?	147
[:SENSe]:SFRequency:PNOFrequency?	147
[:SENSe]:SFRequency:SOFFset <value>	148
[:SENSe]:SFRequency:SOFFset:BANDwidth BWIDth[:RESolution] :RATio <value>	148
[:SENSe]:SFRequency:SOFFset:BANDwidth BWIDth[:RESolution] :RATio?	148
[:SENSe]:SFRequency:SOFFset?	148
[:SENSe]:SFRequency:SWEep:TIME <value>	148
[:SENSe]:SFRequency:SWEep:TIME:AUTO ON OFF 1 0	149
[:SENSe]:SFRequency:SWEep:TIME:AUTO?	149
[:SENSe]:SFRequency:SWEep:TIME?	149

1 Getting Started

Introduction

The Option 226 Phase Noise Measurement Personality is a downloadable program (DLP) that is used with the PSA and ESA-E Series spectrum analyzers to make single sideband phase noise measurements. You need the following equipment to use the utility:

Table 1-1 **Equipment/Upgrades Required for Using Option 226**

analyzer	Firmware	B72 (Extended Memory Option)
E4401A	A.08.00 or later	Required
E4402B	A.08.00 or later	Required
E4404B	A.08.00 or later	Required
E4405B	A.08.00 or later	Required
E4407B	A.08.00 or later	Required
E4440A	A.02.00 or later	Not applicable
E4443A	A.02.00 or later	Not applicable
E4445A	A.02.00 or later	Not applicable

The following procedures describe how to install the file and access the personality.

Specifications

Performance specifications can be found in the “ESA Series Specifications Guide” or the “PSA Series Specifications Guide”.

Licensing the Phase Noise Personality

In order to start using the features of the phase noise personality, it must be licensed. To license your phase noise personality use the following procedure.

NOTE

If your analyzer came with the phase noise personality installed, you can skip the Licensing and Installation instructions.

1. Turn on the spectrum analyzer. After the analyzer has completed the power up sequence:
Press **System**, **More 1 of 3**, **More 2 of 3**, **Licensing**.
2. Press **Option**, and use the numeric key pad to enter the number of the option. For the phase noise personality the option number is 226.
3. Press **Return** to go back to the licensing menu and select **License Key**. Use the numeric key pad and the alpha editor softkeys to enter the appropriate licensing keyword for your spectrum analyzer.

NOTE

If a licensing keyword was not provided, get in touch with your Agilent Technologies representative. Refer to [Table 6-1 on page 152](#) for further details.

4. Press **Return** to go back to the licensing menu. Press **Activate** to enable the license for your downloadable personality.

Installing the Phase Noise Personality on ESA Analyzers

NOTE These installation instructions apply only to 'E' series analyzer models E4401B, E4402B, E4404B, E4405B and E4407B.

The phase noise personality comes on one floppy disk. To install the utility into the spectrum analyzer use the following steps.

1. Press **System**.
2. Press **More 1 of 3**, **More 2 of 3**, then **Personalities**. The display screen will list the personalities currently installed in your spectrum analyzer.
3. Insert your phase noise personality floppy disk into the analyzer's disk drive and press **Install**. The installer utility will ask you to install or verify the disk. Press **Install Now** to install the personality.

NOTE Previously installed versions of the phase noise personality will be overwritten when the new personality is installed. If you try to install a version of the personality which has already been installed, the installation will be skipped.

4. After the installation is complete exit the installer by pressing **Exit Installer** and power cycle the analyzer.
5. To verify that the phase noise personality was properly installed, press **MODE**, and check that **Phase Noise** is present.

Removing the Phase Noise Personality on ESA Analyzers

NOTE

These removal instructions apply only to 'E' series analyzers models E4401B, E4402B, E4404B, E4405B and E4407B.

To uninstall the phase noise personality from the spectrum analyzer use the following steps:

1. Press **System**, **More 1 of 3**, **More 2 of 3**, and then **Personalities**.
2. Press **Uninstall**, and using the up ↑ and the down ↓ arrows select the "Phase Noise Personality" field.
3. Press **Uninstall Now**. The analyzer will ask you to confirm the command by pressing **Uninstall Now** again. The phase noise personality will now be uninstalled.

Installing the Phase Noise Personality on PSA Analyzers

NOTE These installation instructions apply only to PSA analyzer models E4440A, E4443A and E4445A.

When you install a measurement personality, you follow a two step process.

1. Install the measurement personality firmware into the analyzer memory. See [“Loading an Optional Measurement Personality” on page 22.](#)
2. Enter a license key number that activates the measurement personality. See [“Installing a License Key” on page 23.](#)

Adding additional measurement personalities requires purchasing a retrofit kit for the desired option. The retrofit kit contains the measurement personality firmware and a license key certificate. It documents the license key number that is for your specific option and analyzer serial number.

Available Measurement Personality Options

Available Personality Options ^a	Option
GSM (with EDGE) measurement personality	202
cdmaOne measurement personality	BAC
NADC, PDC measurement personalities	BAE
W-CDMA measurement personality	BAF
cdma2000 measurement personality	B78
Phase noise measurement personality	226

a. Available as of the print date of this guide.

You need two pieces of information about your analyzer to order a retrofit kit adding an option. You need the Host ID, and the analyzer serial number.

Required Information:	Key Path:
Host ID: _____	System, Show System

Required Information:	Key Path:
analyzer Serial Number: _____	System, Show System

NOTE The analyzer must have Option B7J in order to add most of the measurement personality options. (Basic, cdmaOne, cdma2000, W-CDMA, GSM, EDGE, NADC, PDC.)

Loading an Optional Measurement Personality

You must load the desired option into your analyzer memory. Loading can be done from a CD-ROM or a www location. The automated loading program runs from your PC and comes with the firmware.

NOTE When you add a new option, or update an existing option, you will get the updated version of all your current options since they are reloaded simultaneously. This process may also require you to update the analyzer core firmware so that it is compatible with the new option.

You may not be able to fit all of the available measurement personalities in analyzer memory at the same time. The approximate memory requirements for the options are listed below. These numbers are worst case examples. Many options share components/libraries so the total memory usage of multiple options may not be exactly equal to the combined total.

Available Personality Options	File Size (PSA - A.02.06)
GSM (with EDGE) measurement personality	3.3 MB
cdmaOne measurement personality	2.0 MB
NADC measurement personalities	1.3 MB
PDC measurement personalities	1.4 MB
W-CDMA measurement personality	4.2 MB ^a
cdma2000 measurement personality	3.8 MB ^a
Phase noise measurement personality	2.6 MB
Shared measurement library	1.5 MB

a. This application uses the shared library, so you have to add its memory requirements to this value.

You can install an updated version of firmware and your licensed options using a LAN connection and your PC. Instructions for loading future firmware updates are available at the following URL:

www.agilent.com/find/psa/

Installing a License Key

To install a license key number for the selected option, use the following procedure.

NOTE

You can also use this to reinstall a license key number that has been deleted during an uninstall process, or lost due to a memory failure

1. Press **System, More, More, Licensing, Option**. The **Option** key accesses the alpha editor menu. Use the alpha editor to enter letters (upper-case) and the front-panel numeric keys to enter numbers for the option designation. Then press **Enter**. As you enter the option, you will see your entry in the active function area of the display.
2. Press **License Key**. Enter the letters/digits of your license key. You will see your entry in the active function area of the display. When you have completed entering the license key number, press **Enter**.
3. Press **Activate License**.

Viewing a License Key

Measurement personalities purchased with your analyzer have been installed and activated at the factory. You will receive a unique **License Key** number with every measurement personality purchased. The license key number is a hexadecimal number that is for your specific measurement personality, analyzer serial number and host ID. It enables you to install, or reactivate that particular personality.

Follow these steps to display the unique license key for a measurement personality that is already installed in your analyzer:

1. Press **System, More, More, Licensing, Show License**. The **System, Personalities** key shows you if the option has been activated.

You will want to keep a copy of your license key number in a secure location. Please enter your license key numbers below for future reference. If you should lose your license key number, call your nearest Agilent Technologies service or sales office for assistance.

License Key Numbers for analyzer with Serial # _____ Product # _____
For Option _____ the license key number is _____
For Option _____ the license key number is _____
For Option _____ the license key number is _____
For Option _____ the license key number is _____
For Option _____ the license key number is _____

License Key Numbers for analyzer with Serial # _____ Product # _____
For Option _____ the license key number is _____

Using the Delete License Key

The following procedure removes the license key number for the selected option. This will make the option unavailable for use. Please write down the 12-digit license key number for the option before proceeding. If you want to use that measurement personality at a later date you will need the license key number to reactivate the personality firmware.

NOTE

Using the **Delete License** key does not remove the personality from the analyzer memory, and does not free memory to be available to install another option. If you need to free memory to install another option, refer to the instructions for loading firmware updates located at the URL: www.agilent.com/find/psa/

1. Press **System, More, More, Licensing, Option**. Pressing the **Option** key will activate the alpha editor menu. Use the alpha editor to enter the letters (upper-case) and the front-panel numeric keyboard to enter the digits (if required) for the option, then press **Enter**. As you enter the option, you will see your entry in the active function area of the display.
2. Press **Delete License** to remove the license key from memory.

Starting the Phase Noise Personality

The phase noise personality can be started easily once the program has been licensed and installed.

Press **MODE**, then **Phase Noise** to start the utility.

2

Using the Phase Noise Personality

Using the Phase Noise Personality

This chapter includes the following:

- **Functionality**
 - Log Plot Measurements
 - Spot Frequency Measurements
 - Smoothing, Averaging, and Filtering
 - Signal Tracking
- **Measurement Considerations**
 - Slowly Drifting Signals
 - System Noise Floor
 - Display Accuracy at 10 dB Per Division
- **Cancellation and Log Plot Measurements**
 - Creating DANL Floor Reference
 - Using DANL Reference for Cancellation - Example Measurement
 - Creating Signal Phase Noise Reference
 - Using Signal Phase Noise Reference for Cancellation - Example Measurement
 - Saving and Restoring Reference Traces
- **Other Documentation**

Functionality

Log Plot Measurements

The log plot measurement approximates a logarithmic frequency sweep with a set of linear sweeps that are pieced together. This gives a display of dBc/Hz versus logarithmic frequency offset for the single sideband measurement. Trace 1, which is the yellow trace, displays the point-by-point data as measured. Trace 2, the cyan blue trace, displays a smoothed version of trace 1. The amount of smoothing is determined by the current setting of the smoothing parameter. With the default settings, marker 1 is set to a frequency offset of 10 kHz, and the phase noise at that frequency is displayed numerically.

NOTE

The Trace numbers, trace data and marker data referred to (above) apply if you are using the factory default settings, but these can be changed.

If the analyzer is set up to perform single sweeps, the **Measure Log Plot** softkey or the **Restart** key allow a measurement to be repeated with a single key press. This is useful for seeing effects of circuit changes where the carrier and offset frequencies of interest do not change. The analyzer can also be set up to perform continuous sweeps. In this case a new measurement will be started as soon as the previous one has completed. One way of setting continuous sweeps is to press the **Sweep** front panel key followed by the **Sweep (Cont)** softkey. The other way is to press **Meas Control** and **Measure (Cont)**.

Up to four markers can be used to display various parameters of the measurement, although the default display only shows data for one marker. Setting **Marker Table** to **On** allows you to view the data from all of your markers at once.

Phase noise measurement results can be integrated over a selected frequency range to get the total RMS (root mean squared) noise in a given bandwidth. The frequency limits used for integration may be selected by pressing **Marker** then **RMS Noise**. Use the RPG knob or front panel keys to select the starting point of your frequency range, and then select whether to display the result in radians or in degrees, or in seconds if **RMS Jitter** is selected. Now you can use the RPG knob or front panel keys to select the end point of your frequency range. The results are displayed in radians, degrees or seconds, depending on your previous selection.

RMS Residual FM over a specified range can also be displayed using markers. Using a **Normal** marker, use the RPG knob or front panel keys to position the marker at the start of your frequency range. Then press **Residual FM**, and use the RPG knob (or the front panel keys) to position

the second marker at the end point of your frequency range. The display will show your frequency range and the measured RMS residual FM over this range. RMS phase noise measurements are based on the log plot data which is a single-sideband measurement. The RMS phase noise results are therefore single-sideband.

Spot Frequency Measurements

A spot frequency measurement is a single sideband measurement of the phase error at a specified offset frequency from the main carrier signal. The average value of the trace points displayed on the screen is indicated by a magenta pink line. The analyzer is normally set up to display a continuous sweep, although a single measurement can be performed by pressing by setting the **Sweep** option to **Single**.

The analyzer can be set up to track a drifting signal by pressing **Frequency** and then setting **Signal Track** to **On**. When signal tracking is **On**, a trace showing the change in frequency against time is shown next to the spot frequency trace.

Smoothing, Averaging and Filtering

Repeatability on the trace can be improved in several different ways. Smoothing is used with log plot measurements while trace averaging is used with spot frequency measurements. Video filtering can be used with both types of measurements.

The smoothing process averages a number of adjacent trace points from the raw trace, typically Trace 1, and displays the smoothed result in second trace, typically Trace 2, for a log plot measurement. Smoothing is faster than averaging or filtering, but less accurate than either. Loss of accuracy is particularly noticeable when a trace has sudden changes in amplitude, for example when a carrier has a large discrete signal such as a spurious sideband. To smooth a trace, choose the **Smoothing** softkey in **Meas Setup**, and then adjust it between 0.00% and 16.0% using either the front panel keys or the RPG knob. While inside the log plot measurement each level of smoothing can be tried without having to make a new measurement.

Video filtering can be applied to the active trace when making measurements. Additional video filtering can increase the accuracy and repeatability of the measurement, but it will also make the measurement process slower. Filtering changes the ratio of the video bandwidth to the resolution bandwidth. Filtering is slower than smoothing or averaging, but is more accurate than either.

The averaging process measures each frequency point multiple times, and then calculates and plots the average value.

Signal Tracking

Signal tracking can be used in all measurements to track a slowly drifting signal. When it is enabled (**On**), the measurement will follow a slowly drifting signal by periodically reacquiring the carrier signal.

How often the analyzer will retune to the drifting signal depends on the measurement being performed, and on analyzer settings such as

tracking mode, drift span and tolerance. Log Plot and Monitor Spectrum do not have tolerance or drift span settings.

If the signal is not tracked correctly (such as might happen with a rapidly drifting signal), the analyzer may not be completely compensating for the drift, causing the measured phase noise to appear either higher or lower than it actually is.

Measurement Considerations

Slowly Drifting Signals

Spot frequency and log plot measurements can be made on slowly drifting signals by making use of the signal tracking function, although the measured value will be slightly inaccurate. The maximum drift rate that can be tracked will depend on analyzer settings such as **Search Span** and the tracking **Mode**, although it is unlikely that you will approach these limits in practice.

System Noise Floor

The system noise floor can have a significant effect on low phase noise measurements such as those that will typically be found at large frequency offsets. The system noise floor can be measured using one of two methods. For greater accuracy, use the Removal method of measurement, and for greater convenience, use the Attenuation method. See [Cancellation and Log Plot Measurements on page 34](#) for more details.

Display Accuracy at 10 dB Per Division

When the amplitude scale setting is 10 dB per division, the phase noise measurements are most accurate in the upper half of the display. In particular, if the measurements are occurring in the bottom 1½ divisions of the display, it is best to decrease the reference level until the result is displayed in the upper half.

To change the scale setting to 10 dB per division, press **AMPLITUDE**, then **Scale/Div**.

Cancellation and Log Plot Measurements

Many phase noise measurements do not benefit from cancellation. If the phase noise of your DUT is more than 10 dB higher than the analyzer noise, then cancellation has almost no effect on the calculated measurement data. The effectiveness of using the cancellation function also has a lower limit. When the phase noise of your DUT gets very close to the analyzer noise (within about 0.1 dB), the logarithmic nature of the calculation results in large, invalid cancellation values. The following table shows error cancellation values that will be applied to the measurement results for various DUT to analyzer phase noise ratios. Setting the threshold value limits the correction that will be applied.

Phase Noise of DUT relative to Phase Noise of Analyzer	Measurement Error Before Cancellation ^a	Threshold Δ Required for Maximum Cancellation
20 dB	0.043 dB	20.0 dB
10 dB	0.41 dB	10.41 dB
0 dB	3.01 dB	3.01 dB
-5.87 dB	6.87 dB	1.0 dB
-10 dB	10.41 dB	0.41 dB
-16.33 dB	16.43 dB	0.1 dB
-20 dB	20.04 dB	0.04 dB
-26.83 dB	26.84 dB	0.01 dB

a. Only considers error due to additive affects of analyzer noise and DUT noise.

Background Information

When you make a phase noise measurement on a given signal, the measurement result that you get is actually a combination of three different noise sources. The first, of course, is the phase noise of the signal that you are measuring. If this noise is very small, it can be distorted or even hidden by the two other noise sources which are generated by the analyzer itself.

The first internal noise source is the phase noise generated by the analyzer as a side-effect of measuring an input signal. The second source is the Displayed Average Noise Level (DANL) of the analyzer. The DANL is the internally generated noise of the analyzer regardless

of whether or not an input signal is present, so the DANL is derived from the noise figure of the analyzer. The DANL Floor is broadly flat across the spectrum and represents the absolute noise level below which measurements cannot be made because the signal gets lost in the analyzer noise.

If you make a measurement without any input signal, that measurement represents the absolute noise floor (DANL) of the analyzer. If you reference this absolute noise floor to the carrier amplitude, the DANL floor becomes a relative limit below which phase noise sidebands cannot be measured.

At far offset frequencies, the analyzer's phase noise is often below the analyzer's noise floor (DANL). The DANL floor of an analyzer thus limits the range over which an analyzer can measure phase noise. By making a log plot measurement of the analyzer's DANL noise floor, you are able to characterize the DANL limitation on phase noise measurements.

Log Plot Cancellation

The Log Plot measurement accuracy on low phase noise DUTs can be improved by using the cancellation feature to remove the affects of the analyzer's internal noise. This is done by comparing a stored reference measurement with the DUT's measured phase noise.

The stored reference measurement can be generated two ways.

- If you have a signal source that has much better phase noise than the analyzer's phase noise, then you can measure that source and know that the resulting trace represents the analyzer's internal phase noise when an input signal is present.
- If you do not have a good low-phase noise source, you can make a reference measurement with no input signal. This gives you a measurement of the analyzer's noise floor (DANL).

A reference trace from a good source that is relatively free of phase noise will let you compensate for both the phase noise and the DANL of the analyzer. A reference trace that is derived from the DANL only compensates for the DANL portion of the noise, but this may be adequate for measurement conditions where the analyzer DANL is the limiting factor (typically for offsets >1 to 10 MHz.)

For future use, this reference trace can be saved to the analyzer's own internal file system (the C: drive) or to a floppy disk. It can then be automatically subtracted from any subsequent log plot measurement to give you a more accurate result.

General Process

Step 1. Set up the analyzer as needed to measure the test signal's phase noise.

(i.e. Use the same frequency range as needed for your intended DUT measurement.)

- Step 2.** Create and save a reference trace in Trace 3. Create either a DANL reference or a signal phase noise reference. (See “[Creating a DANL Floor Reference Trace](#)” on page 37 or “[Creating a Signal Phase Noise Reference Trace](#)” on page 40.)
- Step 3.** Set up the analyzer so it is making a log plot measurement of the DUT's phase noise and turn on the cancellation using the saved reference trace data.

Creating a DANL Floor Reference Trace

The reference trace must cover the same frequency range as your intended measurement.

- Step 1.** With the carrier signal connected, set up the analyzer to measure the phase noise over the desired frequency range.
- Step 2.** Press **Measure, Log Plot**.
- Step 3.** Set up the DANL floor measurement. Press **Meas Setup, Meas Type, DANL Floor**.
- Step 4.** Press **Input/Output** and **DANL Method**, to select either the `Atten` (Attenuation) or the `Removal` method for making the DANL measurement. (The `Removal` method will prompt you for additional steps.)
- Step 5.** Press **Restart**. You now have a reference trace available that you can either use immediately or save for later use. See the information about saving and restoring traces later in this section.

Example Measurement - Using a DANL Reference for Cancellation

Measuring a DANL Reference Trace

- Step 1.** With the test signal connected, set the analyzer to its startup condition by pressing **Preset**.
- Step 2.** Turn filtering on and set it to the maximum level. Press **Meas Setup, Filtering** and **Maximum**.
- Step 3.** Turn averaging on and set it to an appropriate level. Press **Meas Setup, Avg Number** (setting to **On** or **Off**), and enter an appropriate number if setting **Averaging On**.
- Step 4.** Select the frequency range that you want to use for your reference trace. Press **X Scale** and **Start Offset** to specify the start of the frequency range, and **X Scale, Stop Offset** to specify the end of the frequency range. The range must be the same range that you will be measuring on your test signal.
- Step 5.** Set up and make the DANL floor measurement. Press **Meas Setup, Meas Type, DANL Floor** and **Restart**.
- Step 6.** Select which of the two possible methods of DANL floor measurement is to be made. Press **Input/Output** and **DANL Method**, and then select either the `Atten` (Attenuation) or the `Removal` method of DANL measurement.

Step 7. Press **Restart**. If you selected the Signal Removal method of DANL measurement, you will be asked to disconnect the input signal from the analyzer and to replace it with a 50Ω termination.

If you selected the attenuation method of measurement, the analyzer will effectively remove the input signal by automatically setting the attenuation to its maximum level of 70 dB. Whichever method is used, the analyzer will go through the measurement as if a signal was still present. The displayed average noise is measured and treated as phase noise, and normalized to the carrier amplitude. The DANL phase noise is then displayed as the phase noise trace.

Step 8. Once the measurement has completed, store the trace data in Trace number 3 by pressing **View/Trace, More 1 of 2, Operations** and **2 -> 3**. You now have a reference trace stored in Trace 3.

Applying Cancellation to a Log Plot Measurement

NOTE For a reference trace to be valid, it must be in View mode, and must cover the same frequency range as your intended measurement.

- Step 1.** Go to the Cancellation menu under the Meas Setup menu. To do this, press **Meas Setup, More 1 of 2** and **Cancellation**.
- Step 2.** Select the trace that you wish to use as the reference trace (Trace 3). Press **Ref Trace** until the desired trace number is underlined. Trace number 1 is yellow, Trace number 2 is cyan blue and Trace number 3 is magenta pink.
- Step 3.** Set the threshold if required, although you will not normally have to change this value. The noise cancellation measurement compares your current measurement with the reference trace on a point by point basis. At each point, the current measurement has to exceed the reference trace by at least the threshold level. If the difference between the source trace and the reference trace is less than the threshold level, then the source trace is assumed to be exactly the threshold level above the reference level. To set the threshold level, press **Meas Setup, More 1 of 2, Cancellation** and **Threshold**, and then set your threshold level in dB.
- Step 4.** Turn the cancellation **On** by pressing **Meas Setup, More 1 of 2, Cancellation** and **Cancellation** again. Any trace that is displaying smoothed data will change immediately to reflect the noise

cancellation.

Table 2-1 Parameters of Interest When Performing a DANL Measurement

Parameter	Front Panel Access	Description
DANL Method	Input/Output, DANL Method	Determines which of the two possible methods is used to measure the DANL Floor.
Max Mixer Level	Input/Output, Advanced, Max Mixer Level	Determines the amount of input attenuation to use, depending on the measured carrier amplitude and the particular offset being measured.
Blanking the raw data trace	(When using the default settings) View/Trace, Trace 1, Blank	The trace of the raw data (normally the yellow trace) can sometimes get in the way when you are working with smoothed traces. The raw data trace can be blanked out to leave just the smoothed traces on display.
Trace Zooming	X Scale or Y Scale	Ensure that the measurement is in single sweep, and then use the RPG knob, the step keys or the numeric keypad to zoom in on a particular frequency range. As long as you are in Single Sweep mode, you do not need to make another measurement.
Decade Table	Meas Setup, More 1 of 2, Decade Table	This displays a table of offset frequencies versus amplitude. It provides an easy way of comparing spot amplitudes on different traces.

Creating a Signal Phase Noise Reference Trace

The reference trace must cover the same frequency range as your intended measurement.

- Step 1.** Set up the analyzer to measure the test signal phase noise over the desired frequency range. Press **Measure, Log Plot**.
- Step 2.** Connect a low phase noise signal source to the input of your analyzer and set it to the desired output frequency.
- Step 3.** Measure the phase noise of your reference signal. Press **Meas Setup, Meas Type, Phase Noise** and **Restart**. This measures and displays the phase noise of your test signal.
- Step 4.** You now have a reference trace available that you can either use immediately or save for later use. See the information about saving and restoring traces later in this section.

Example Measurement - Using a Phase Noise Measurement for Cancellation

Measuring a Signal Phase Noise Reference Trace

- Step 1.** Set the analyzer to its startup condition by pressing **Preset**.
- Step 2.** Turn filtering on and set it to the maximum level. Press **Meas Setup, Filtering** and **Maximum**.
- Step 3.** Turn averaging on and set it to an appropriate level. Press **Meas Setup, Avg Number** (setting to **On** or **Off**), and enter an appropriate number if setting **Averaging On**.
- Step 4.** Select the frequency range that you want to use for your reference trace. Press **X Scale** and **Start Offset** to specify the start of the frequency range, and **X Scale, Stop Offset** to specify the end of the frequency range. The range must be the same range that you will be measuring on your test signal.
- Step 5.** Connect a low phase noise signal source to the input of your analyzer and set it to the desired output frequency.
- Step 6.** Measure the phase noise of your reference signal. Press **Meas Setup, Meas Type, Phase Noise** and **Restart**. This measures and displays the phase noise of your signal. If you are using the analyzer's default settings, the raw data is displayed by the yellow trace, and the smoothed data is displayed by the cyan blue trace.
- Step 7.** Copy the smoothed trace data in Trace 2 (cyan blue) to Trace 3 (magenta pink) for later reference. Press **View/Trace, More 1 of 2**,

Operations and 2 -> 3 to copy the trace data. You now have a reference trace stored in Trace number 3.

Applying Cancellation to a Log Plot Measurement

NOTE For a reference trace to be valid, it must be in View mode, and must cover the same frequency range as your intended measurement.

- Step 1.** Go to the Cancellation menu under the Meas Setup menu. To do this, press **Meas Setup, More 1 of 2** and **Cancellation**.
- Step 2.** Select the trace that you wish to use as the reference trace (Trace 3). Press **Ref Trace** until the desired trace number is underlined. Trace number 1 is yellow, Trace number 2 is cyan blue and Trace number 3 is magenta pink.
- Step 3.** Set the threshold if required, although you will not normally have to change this value. The noise cancellation measurement compares your current measurement with the reference trace on a point by point basis. At each point, the current measurement has to exceed the reference trace by at least the threshold level. If the difference between the source trace and the reference trace is less than the threshold level, then the source trace is assumed to be exactly the threshold level above the reference level. To set the threshold level, press **Meas Setup, More 1 of 2, Cancellation** and **Threshold**, and then set your threshold level in dB.
- Step 4.** Turn the cancellation **On** by pressing **Meas Setup, More 1 of 2, Cancellation** and **Cancellation** again. Any trace that is displaying smoothed data will change immediately to reflect the noise cancellation.

Saving Traces

All traces, including the reference traces used for noise cancellation measurement, can be saved to floppy disk or to the analyzer's own internal file system (C:). All traces are saved in binary format, and their format is independent of the analyzer on which they were saved.

NOTE Traces cannot be saved in older versions of Option 226 Phase Noise Mode (firmware release A.07.xx or earlier).

- Step 1.** Select the trace you would like to save by pressing **View/Trace** and then **Trace**. Press **Trace** until the trace you wish to save is underlined.
- Step 2.** Go to the Load/Save menu which is under the View/Trace menu, and select the drive on which you would like to save the trace. Press **View/Trace, More 1 of 2, Load/Save** and **Drive**.
- Step 3.** Enter your filename. Press **View/Trace, More 1 of 2, Load/Save** and **Filename**, and then use the alphabetic keys to enter your filename. The file extension .LPT will automatically be added to the filename that you enter.
- Step 4.** Save the trace by pressing **View/Trace, More 1 of 2, Load/Save** and **Save Trace**.

NOTE Traces saved using this process in a Log Plot measurement are different than the "normal" traces on ESA and PSA. Traces saved from any other measurement (including measurements in Spectrum Analysis Mode) are not compatible with those saved under Log Plot measurements.

Restoring Traces

All traces, including the reference traces used for noise cancellation measurement, can be loaded from a floppy disk or from the analyzer's own internal file system (C:). All traces are saved in binary format, and their format is independent of the analyzer on which they were saved.

NOTE Traces saved in Phase Noise Mode (Option 226) with older firmware releases may not be transportable to the newer releases.

- Step 1.** Select the trace you would like to replace by pressing **View/Trace** and then **Trace**. Press **Trace** until the trace you wish to replace is underlined.
- Step 2.** Go to the Load/Save menu which is under the View/Trace menu, and select the drive from which you would like to load the trace. Press **View/Trace, More 1 of 2, Load/Save** and **Drive**.
- Step 3.** Enter your filename. Press **View/Trace, More 1 of 2, Load/Save** and **Filename**, and then use the alphabetic keys to enter your filename. The file extension .LPT will automatically be added to the filename that you

enter.

Step 4. Load the trace by pressing **View/Trace, More 1 of 2, Load/Save** and **Load Trace**. The trace is automatically set to View mode so it does not get overwritten.

NOTE

This method of saving and loading traces in a Log Plot measurement is different from the normal method on ESA and PSA analyzers. Traces saved from any other measurement (including measurements in Spectrum Analysis Mode) are incompatible with those saved under Log Plot measurements.

Additional Information

The document listed below provides information on making phase noise measurements. It can be obtained through your local Agilent Technologies office.

Agilent Part Number	Title
1000-1132	<i>RF and Microwave Phase Noise Measurement Seminar</i>

3 Menu Maps

This chapter provides a visual representation of the front-panel keys and their associated menu keys. Refer to [Chapter 4](#), “[Front-Panel Key Reference](#),” on [page 75](#) for key function descriptions.

What You Will Find in This Chapter

This chapter provides menu maps for the front panel keys having associated menus. The key menus appear in alphabetical order as follows:

AMPLITUDE Y Scale—Log Plot	Page 47
AMPLITUDE Y Scale—Spot Frequency	Page 48
BW/ Avg	Page 49
Det/Demod	Page 50
Display—Log Plot	Page 51
Display—Monitor Spectrum	Page 52
Display—Spot Frequency	Page 53
File	Page 54
FREQUENCY Channel	Page 55
Input Output	Page 56
Installer	Page 57
Marker	Page 58
MEASURE	Page 59
Measurement Setup—Log Plot	Page 60
Measurement Setup—Monitor Spectrum	Page 61
Measurement Setup—Spot Frequency	Page 62
MODE	Page 63
Mode Setup	Page 64
SPAN X Scale—Log Plot	Page 65
SPAN X Scale—Monitor Spectrum	Page 66
SPAN X Scale—Spot Frequency	Page 67
Sweep—Log Plot	Page 68
Sweep—Spot Frequency	Page 69
Trig	Page 70
View/Trace—Log Plot	Page 71
View/Trace—Monitor Spectrum	Page 72
View/Trace—Spot Frequency	Page 73

Menus

Amplitude Menu - Log Plot

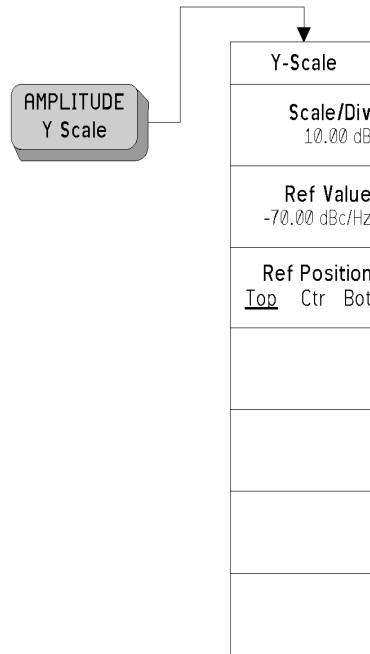

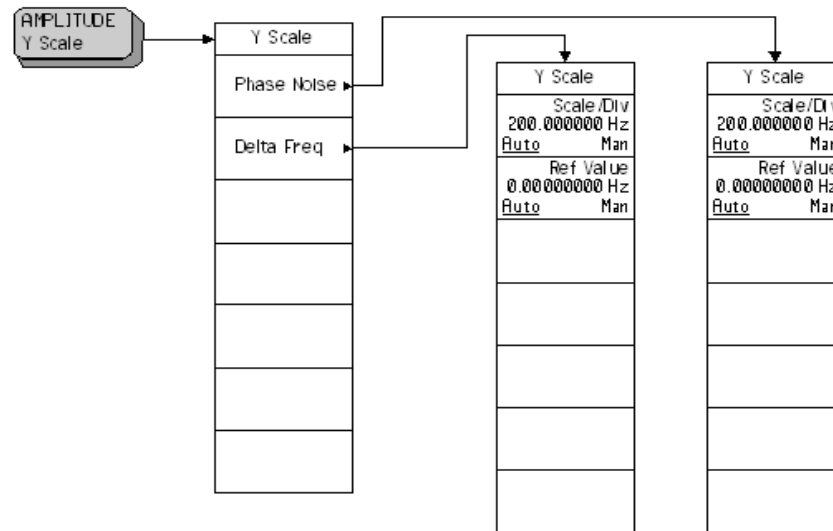
Amplitude Menu - Spot Frequency

BW/Avg Menu



* Grayed out in Spot Frequency and Log Plot measurements

** PSA Series analyzers only

Det/Demod Menus



Display Menus - Log Plot

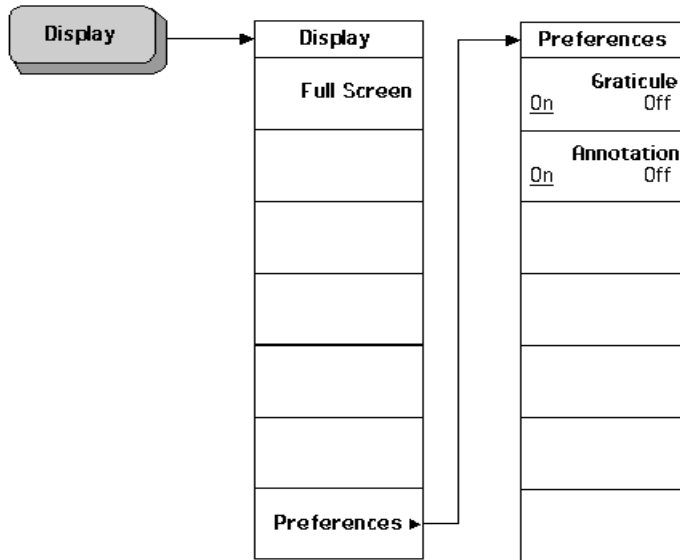

Display Menus - Monitor Spectrum

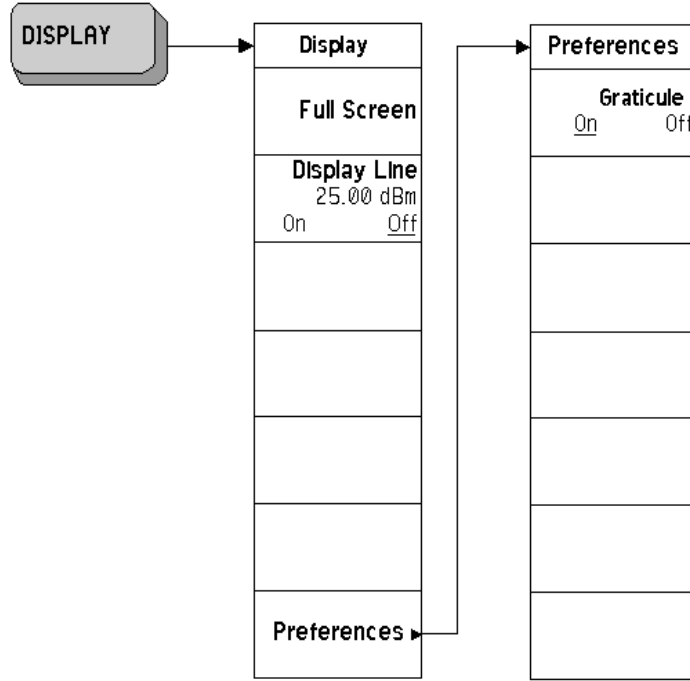

Display Menus - Spot Frequency

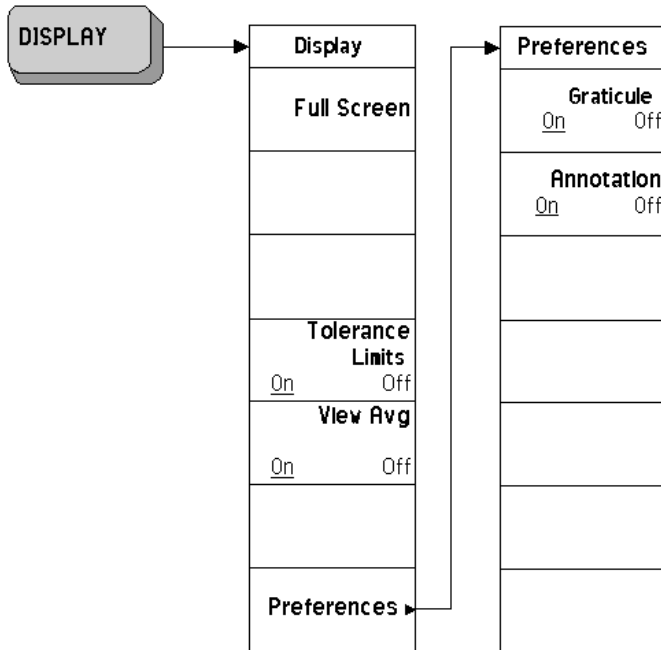

File Menu

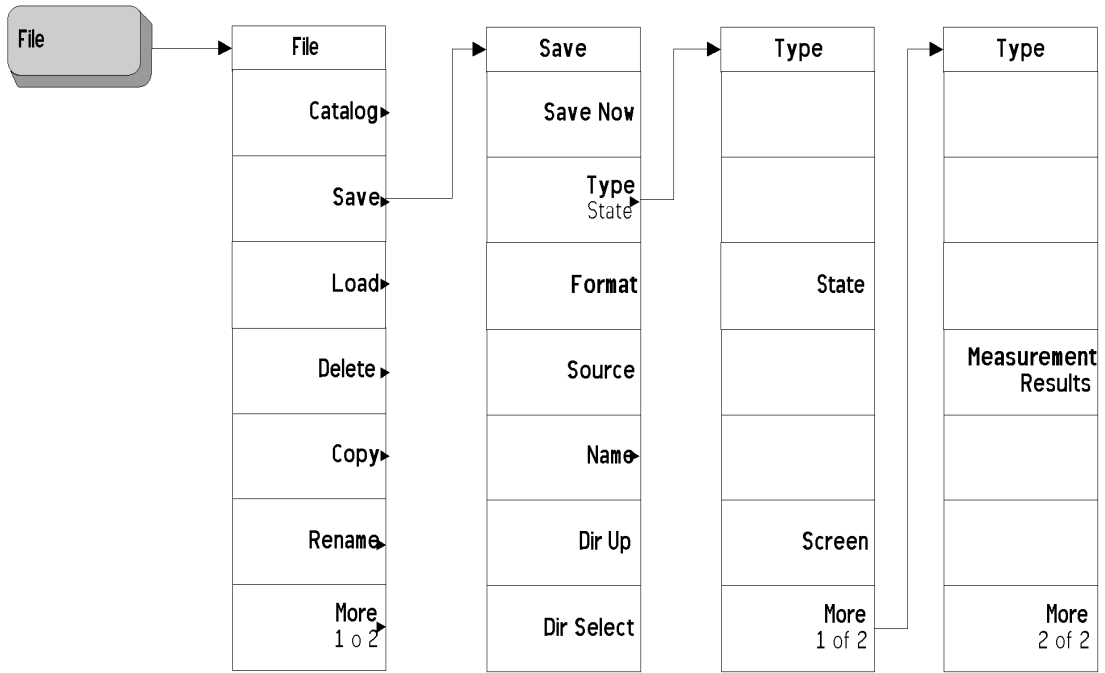

Frequency/Channel Menu

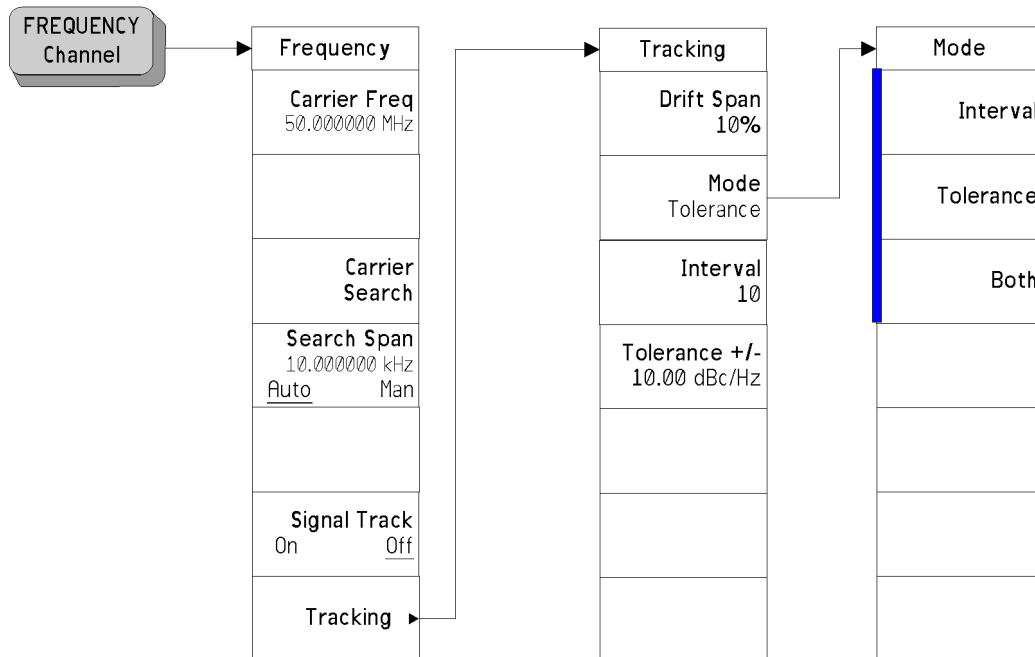

| A bar on the left of two or more softkeys indicates that the keys are a set of mutually exclusive choices.

Input Output Menu

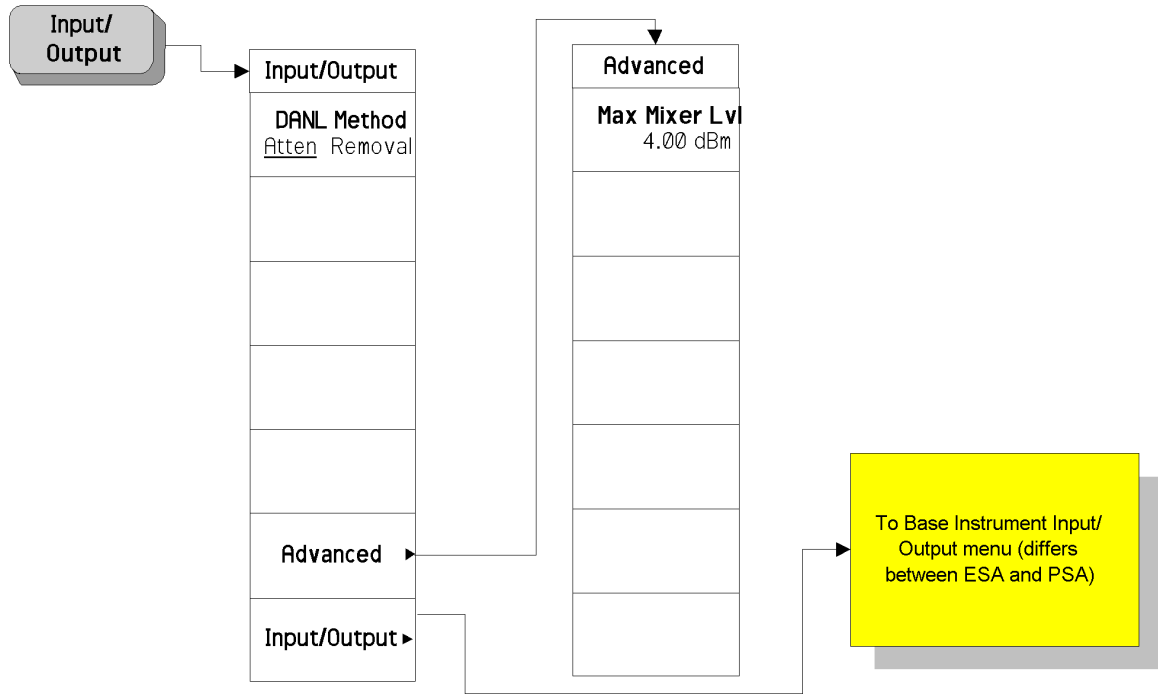

Installer Menu (ESA Series of Analyzers Only)

For more information on the System and Personalities menus, refer to the *ESA Spectrum Analyzers User's Guide*.

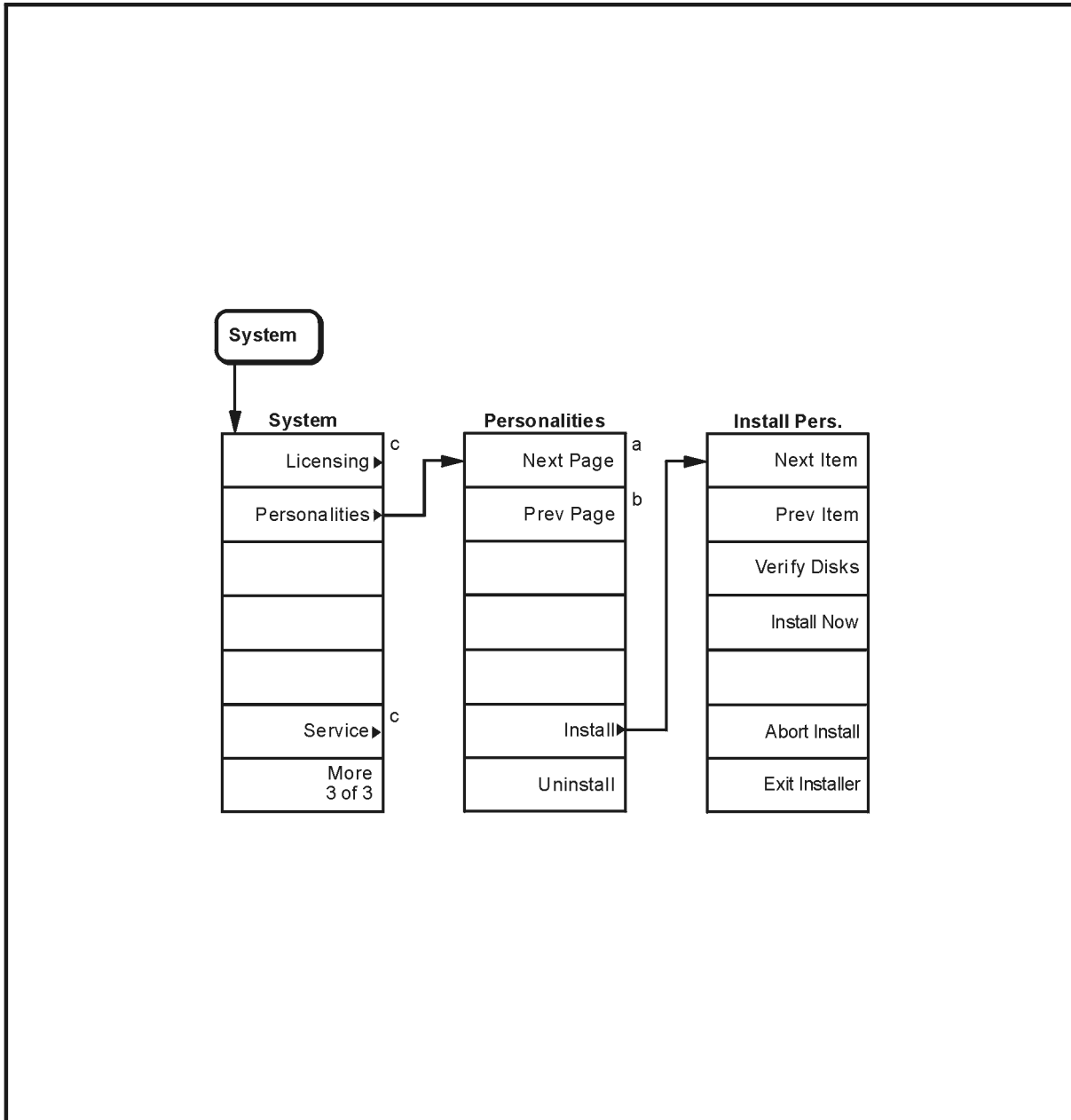

- a. Grayed out when on the last page or if there is only one page
- b. Grayed out when on the first page or if there is only one page
- c. For information on the menu accessed by this key, refer to the *ESA Spectrum Analyzers User's Guide*.

pl737b

Marker Menu - Log Plot

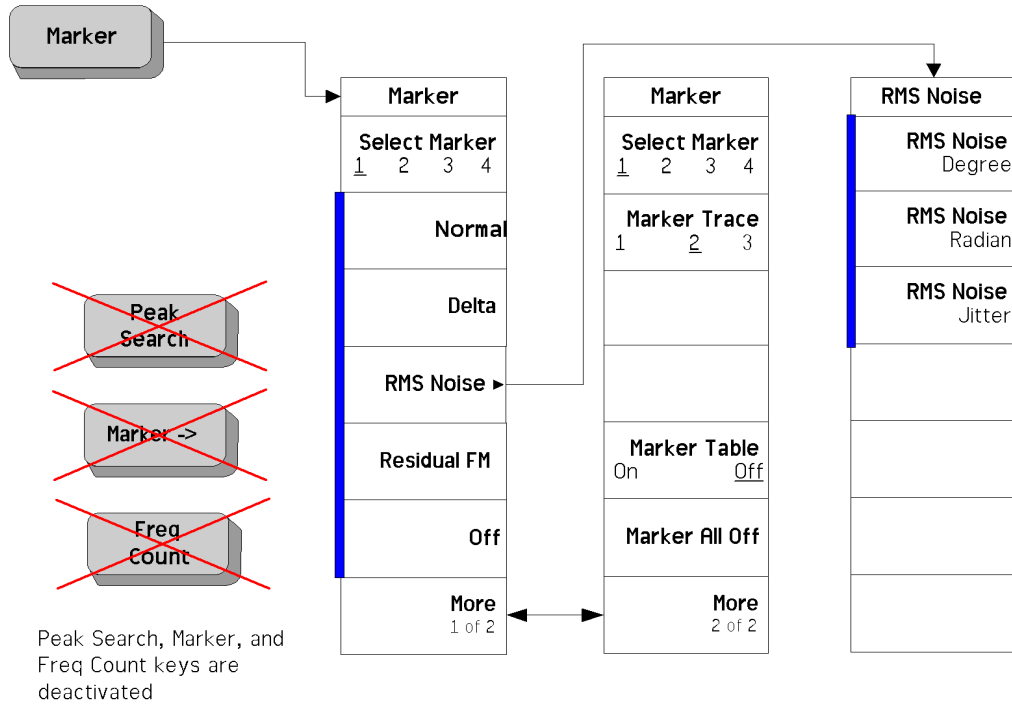

| A bar on the left of two or more softkeys indicates that the keys are a set of mutually exclusive choices.

Measure Menu

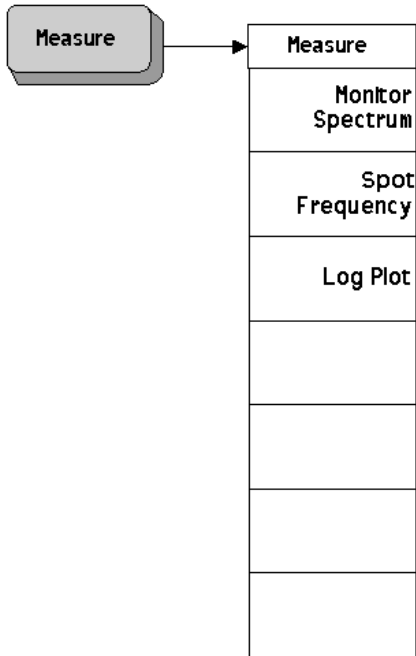

Meas Setup Menus - Log Plot

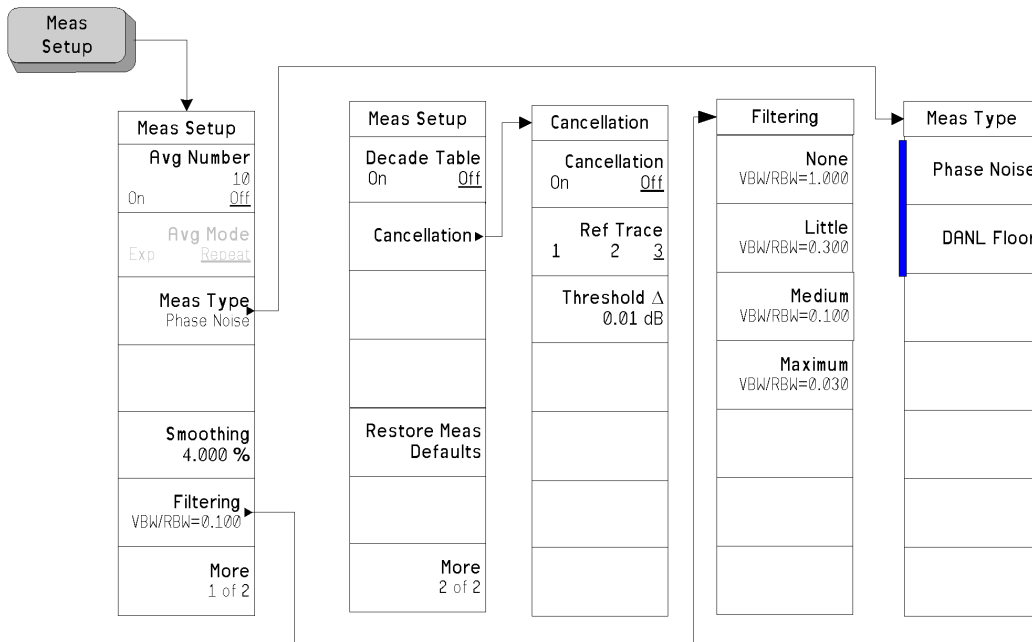

A bar on the left of two or more softkeys indicates that the keys are a set of mutually exclusive choices.

Meas Setup Menus - Monitor Spectrum

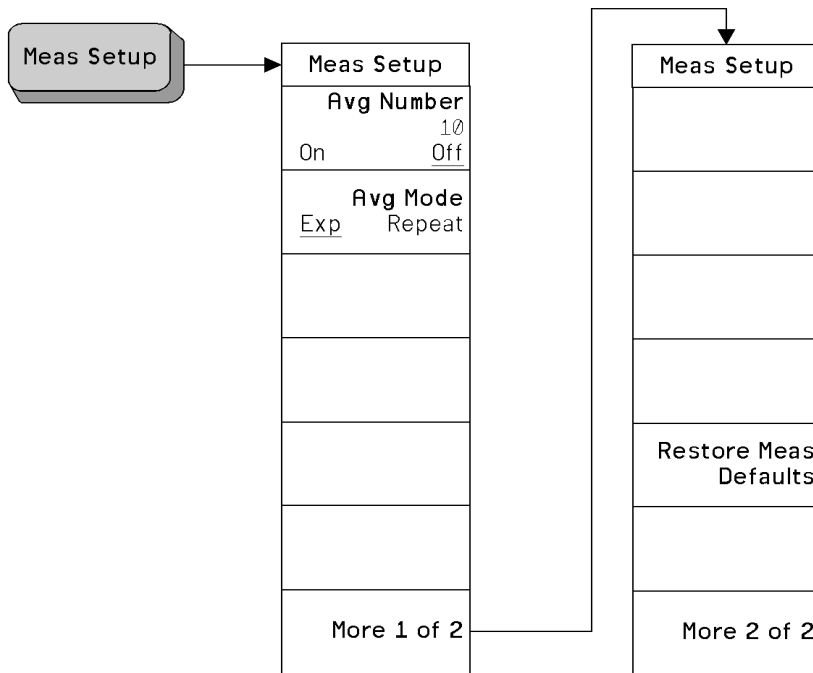

Meas Setup Menus - Spot Frequency

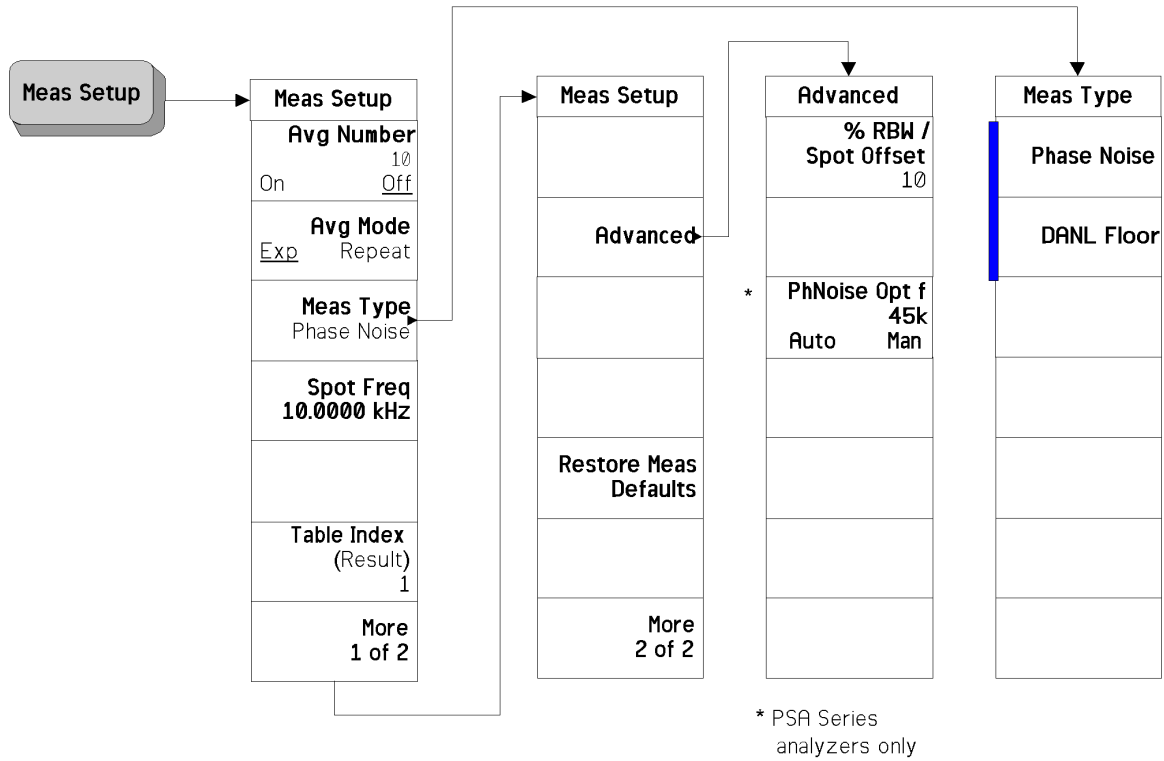

| A bar on the left of two or more softkeys indicates that the keys are a set of mutually exclusive choices.

Mode Menu

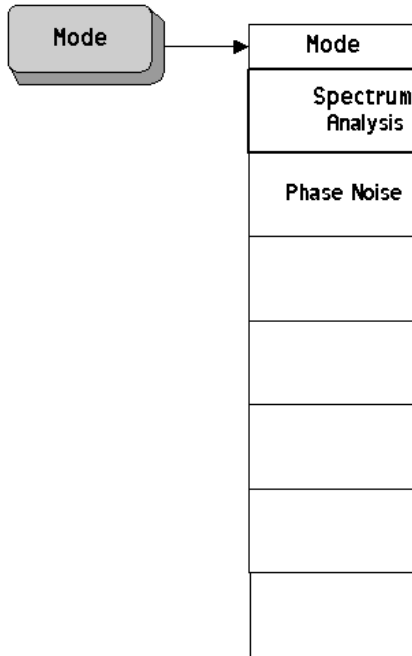

Mode Setup Menus

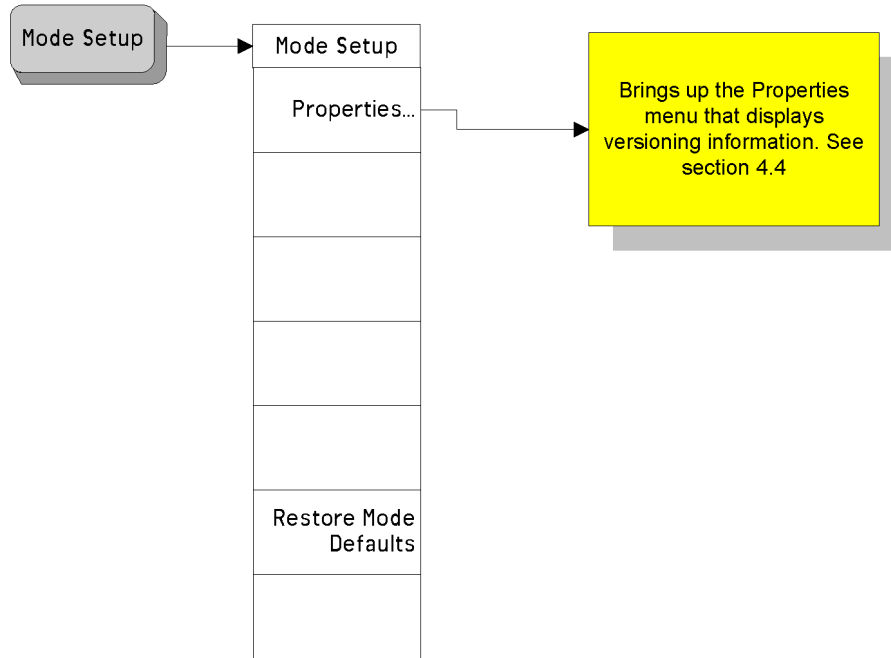

Span (X Scale) Menu - Log Plot



Span (X Scale) Menu - Monitor Spectrum



Span (X Scale) Menu - Spot Frequency

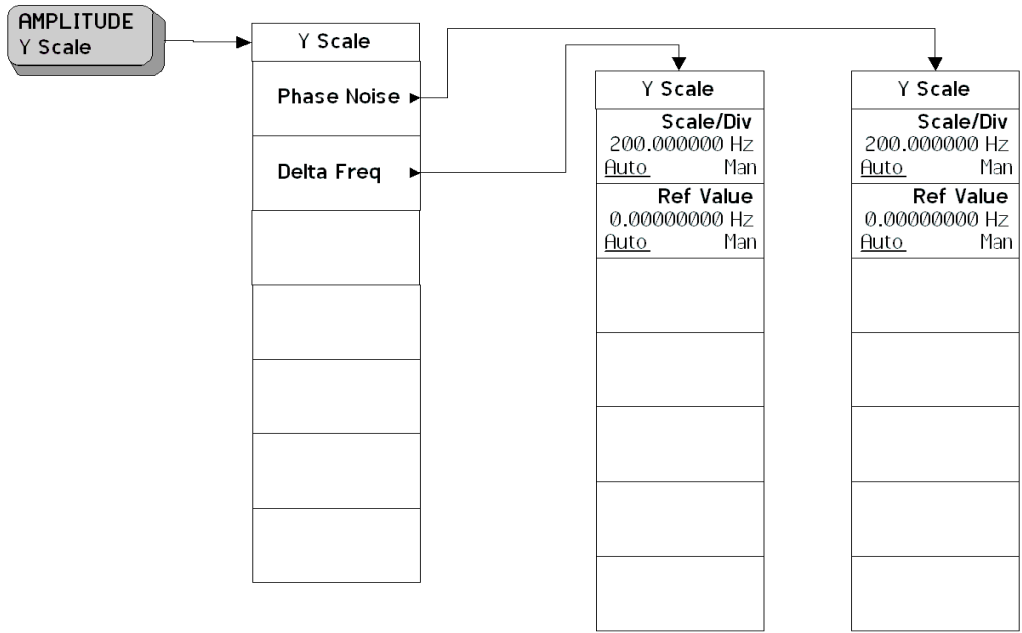

Sweep Menu - Log Plot

PSA Analyzers only

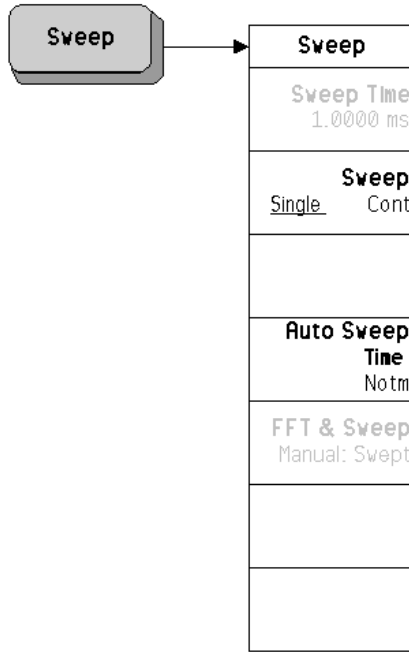

ESA Analyzers only

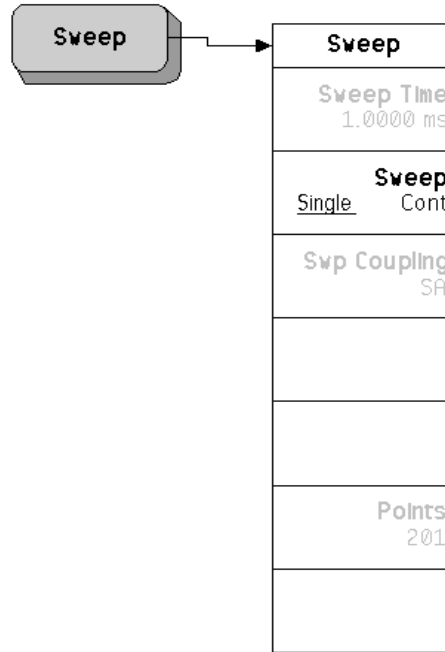

Sweep Menu - Spot Frequency

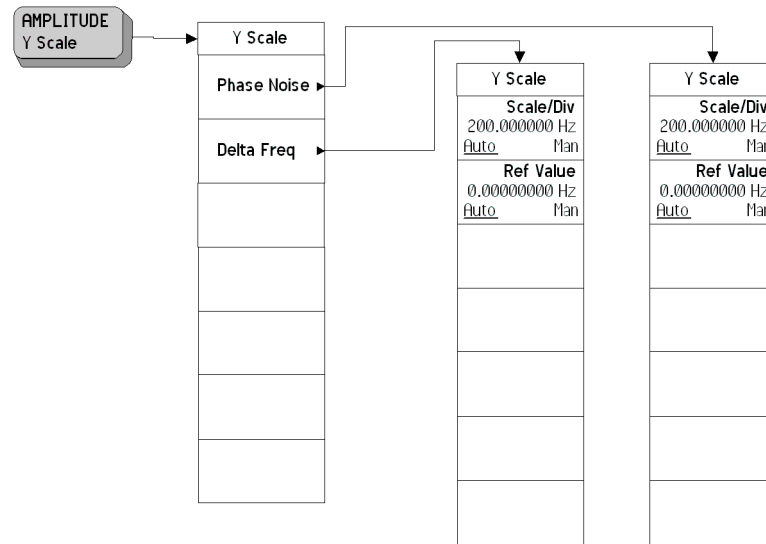

Trigger Menu

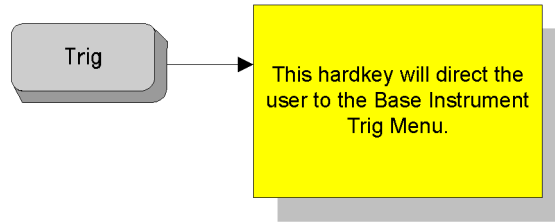

View and Trace Menus - Log Plot

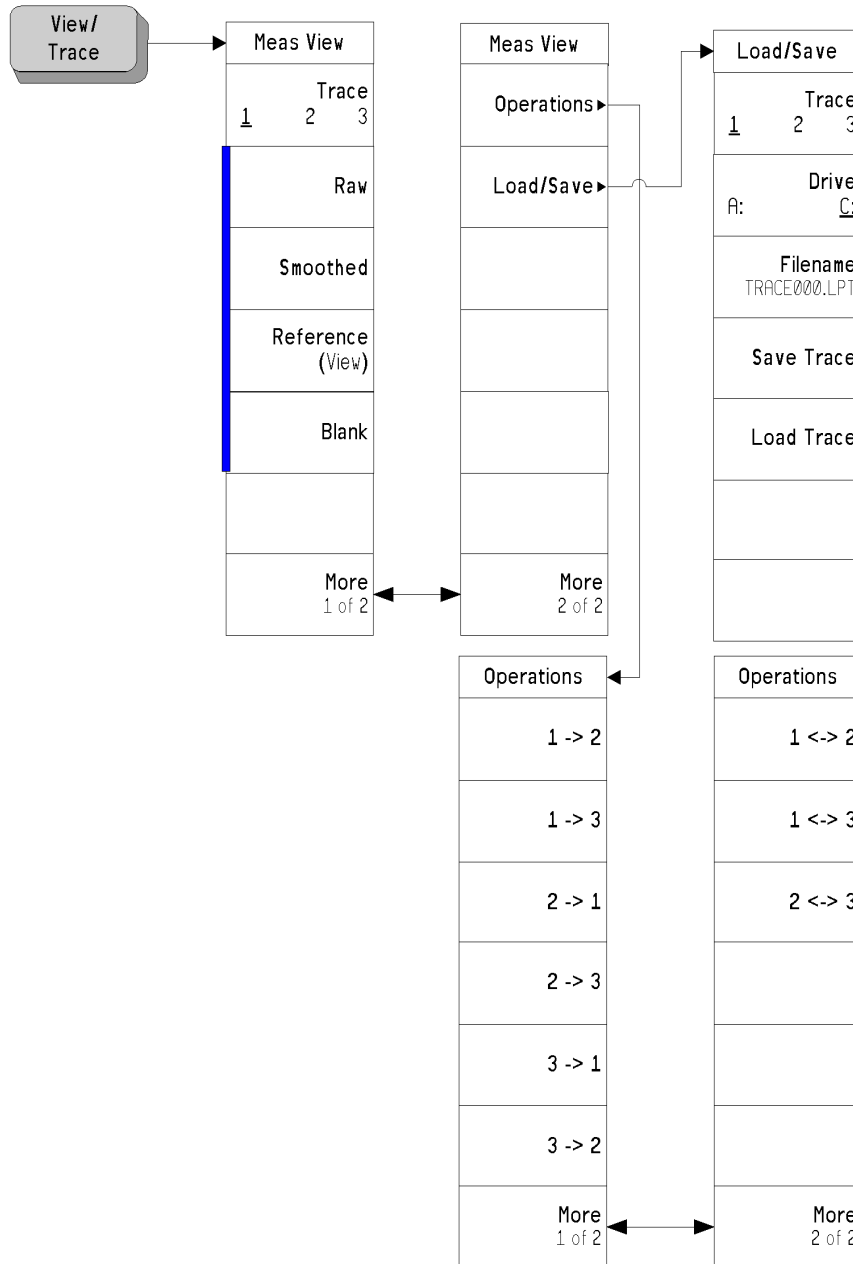

■ A bar on the left of two or more softkeys indicates that the keys are a set of mutually exclusive choices.

View and Trace Menus - Monitor Spectrum

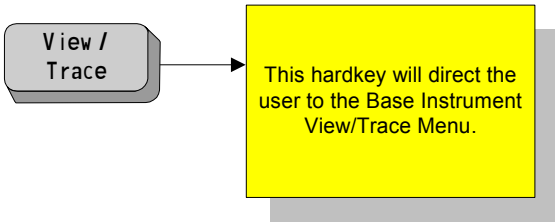

View and Trace Menus - Spot Frequency

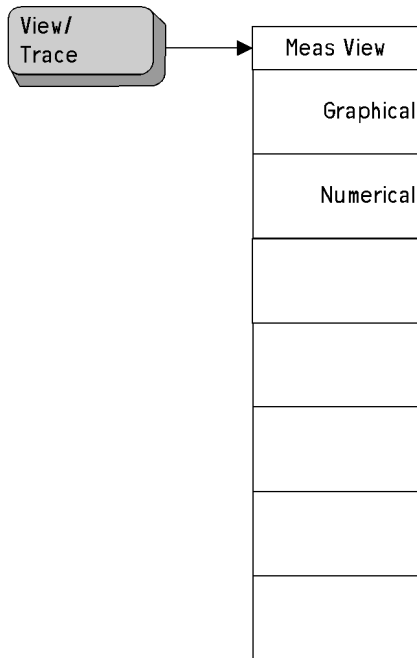

Menu Maps
Menus

4 **Front-Panel Key Reference**

This chapter details the front-panel keys and menu keys that appear on the menu-maps presented in the previous chapter. The front-panel keys are listed alphabetically and are described with their associated menu keys. The menu keys are arranged as they appear in your analyzer menus.

Key Descriptions and Locations

This chapter provides information on Phase Noise mode functions only. Some keys are described that are either not available in Spectrum Analysis (SA) mode, or that provide functions which differ from those provided by the same keys in SA mode. Other keys are described which provide fewer functions than the same key in SA mode, but the functions that are provided are identical in both modes. For those keys not described here, refer to the *PSA Series Spectrum Analyzers User's Guide* and the *ESA Series Spectrum Analyzers User's Guide*.

AMPLITUDE Y Scale	Page 77
Det/Demod	Page 79
Display	Page 80
FREQUENCY Channel	Page 81
Input/Output	Page 83
Marker	Page 84
Meas Setup	Page 87
MEASURE	Page 90
MODE	Page 91
Mode Setup	Page 92
Preset	Page 93
SPAN X Scale	Page 94
Sweep Menu	Page 95
Trace/View	Page 96

AMPLITUDE Y Scale

Activates the reference level function, if it is available, and accesses the amplitude menu keys. Amplitude menu keys are used for setting functions that affect the way data on the vertical axis is displayed or corrected.

Phase Noise	<p>When Signal Tracking is On and a Spot Frequency measurement is being made, the screen is split vertically into two sections. The left half of the screen displays the Phase Noise of the signal being measured, while the right hand half, labelled 'Delta Freq', shows the changes in frequency of the signal. This key allows you to control the appearance of the Phase Noise display.</p> <p>Scale/Div Sets the units per vertical graticule division on the display.</p> <p>Ref Value Sets the value of the reference line on the screen. The reference line is shown in magenta pink.</p>
Delta Freq	<p>When Signal Tracking is On and a Spot Frequency measurement is being made, the screen is split vertically into two sections. The left half of the screen displays the Phase Noise of the signal being measured, while the right hand half, labelled 'Delta Freq', shows the changes in frequency of the signal. This key allows you to control the appearance of the Delta Freq display.</p> <p>Scale/Div Sets the units per vertical graticule division on the display.</p> <p>Ref Value Sets the value of the reference line on the screen. The reference line is shown in magenta pink.</p>
Ref Value	<p>This allows you to set the value in dBc/Hz of a specified position on the graticule display (see Ref Position). This softkey is only available in Log Plot measurements.</p>
Ref Position	<p>The reference position on each trace is indicated by a small chevron (the '>' and '<' signs) at either side of the graticule. The value in dBc/Hz of this reference position on the graticule is specified with the Ref Value softkey. The Ref Position softkey allows you to vary the position of the reference trace between top, center, and bottom of the graticule. This softkey is only available in Log Plot measurements.</p> <p>Top Sets the reference position to the top line of the graticule. Its position is indicated by a small chevron on either side of the graticule.</p> <p>Ctr Sets the reference position to the center of the graticule. Its position is indicated by a small chevron on</p>

Bot either side of the graticule.
Sets the reference position to the bottom line of the graticule. Its position is indicated by a small chevron on either side of the graticule.

Det/Demod

This hard-key is only accessible when making a Monitor Spectrum measurement. It is grayed out at all other times. Please refer to the *PSA Series Spectrum Analyzers Reference Guide* and *ESA Series Spectrum Analyzers User's Guide* for further details.

Display

This front panel key accesses the menu key that allows you to see and setup different measurement displays.

- Full Screen** Extends the measurement window over the entire analyzer display, removing the softkey menu as it does so. To restore the softkey menu, press any key except **Print**, **Save**, or any of the data entry keys.
- Tolerance Limits** When you are tracking a drifting signal and the tracking mode is **Tolerance**, you can choose to display or hide the lines corresponding to the tolerance limits by using this key.
- View Avg** Allows you to display or hide a line on the screen showing the moving average value. The line represents the average value of the measurements showing on the screen.
- Preferences** This displays a further menu giving you control over some aspects of the display's appearance.
- Graticule** Allows you to display or hide the graticule lines on the display.
 - Annotation** Allows you to display or hide some of the annotation pertaining to the current display.

FREQUENCY Channel

Accesses the menu of frequency functions.

Carrier Freq	Allows you to specify the frequency of the carrier wave whose phase noise is to be measured. As long as the frequency you enter is within plus or minus 5% of the carrier signal's true frequency, the analyzer will tune to it automatically.				
Carrier Search	Automatically tunes the analyzer to the strongest signal it can find. If Search Span is set to Automatic , the search is performed from a lower limit of 100Hz to an upper limit of the analyzer's maximum capabilities. When Search Span is set to Manual , the search is performed within the frequency range specified in Search Span , centered on the current carrier frequency.				
Search Span	Determines the spectral range that a Carrier Search will search for a signal. This key toggles between Automatic and Manual settings, and when set to Manual , allows you to enter a frequency range manually. When Search Span is set to Automatic , the search is performed from a lower limit of 100Hz to an upper limit of the analyzer's maximum capabilities. When Search Span is set to Manual , the search is performed within the frequency range specified here, centered on the current carrier frequency.				
Signal Track	Specifies whether or not the analyzer automatically tracks a slowly drifting signal. <table border="0" style="margin-left: 20px;"> <tr> <td style="vertical-align: top;">On</td> <td>When Signal Track is set to On, the analyzer repeatedly measures the frequency of the carrier signal to check for any change that might have occurred, and retunes to the new frequency if necessary.</td> </tr> <tr> <td style="vertical-align: top;">Off</td> <td>When this is set to Off, the analyzer makes its measurement at a fixed frequency.</td> </tr> </table>	On	When Signal Track is set to On , the analyzer repeatedly measures the frequency of the carrier signal to check for any change that might have occurred, and retunes to the new frequency if necessary.	Off	When this is set to Off , the analyzer makes its measurement at a fixed frequency.
On	When Signal Track is set to On , the analyzer repeatedly measures the frequency of the carrier signal to check for any change that might have occurred, and retunes to the new frequency if necessary.				
Off	When this is set to Off , the analyzer makes its measurement at a fixed frequency.				
NOTE	The repeated realignment with the signal when tracking is On causes measurements to take longer than when tracking is Off .				
Tracking	Displays a menu which allows you to control exactly how signal tracking is performed. <table border="0" style="margin-left: 20px;"> <tr> <td style="vertical-align: top;">Drift Span</td> <td>Specifies the span, as a percentage of the carrier frequency, within which the frequency drift will be tracked. For example, if a Drift Span of 12% is specified, the signal will be tracked as long as it remains within plus or minus 6% of the most recent frequency measurement. The drift span is limited to a maximum</td> </tr> </table>	Drift Span	Specifies the span, as a percentage of the carrier frequency, within which the frequency drift will be tracked. For example, if a Drift Span of 12% is specified, the signal will be tracked as long as it remains within plus or minus 6% of the most recent frequency measurement. The drift span is limited to a maximum		
Drift Span	Specifies the span, as a percentage of the carrier frequency, within which the frequency drift will be tracked. For example, if a Drift Span of 12% is specified, the signal will be tracked as long as it remains within plus or minus 6% of the most recent frequency measurement. The drift span is limited to a maximum				

of 50 MHz.

Mode	Displays a menu which allows control over how signal tracking operates. You can select from three modes of operation - Interval , Tolerance or a combination of the two.
Interval	The analyzer will retune to the carrier signal after every Interval number of measurements have been made.
Tolerance	The analyzer will retune to the carrier signal whenever one phase noise measurement differs from the average value by Tolerance percent.
Both	This is a combination of Interval and Tolerance modes. The analyzer will retune to the carrier signal after every Interval number of measurements or whenever the latest phase noise measurement deviates from the average by Tolerance percent, depending on which occurs first.
Interval	The analyzer will retune to the carrier signal after every Interval number of measurements have been made.
Tolerance +/-	The analyzer will retune to the carrier signal whenever one phase noise measurement differs from the average value by Tolerance percent. The tolerance limits are displayed on the screen by parallel green lines.

Input/Output

Displays a menu that allows you to control how noise levels are to be measured and gives you access to the advanced menu.

DANL Method	Allows you to select one of two alternative methods of measuring the Displayed Average Noise Level (DANL).
Atten	Attenuation method attenuates any incoming signal to such an extent that it is almost lost within the background noise. The noise level can then be measured.
Removal	The Removal method of measuring DANL requires the input signal to be physically disconnected from the analyzer before the noise level is measured. The analyzer will tell you when to remove or disconnect the signal, and when to reconnect it afterwards.
NOTE	Every analyzer generates some noise of its own. By measuring this noise level, you can compensate for it and thus obtain more accurate phase noise measurements. The Attenuation method of DANL measurement is accurate enough for most purposes and is generally more convenient, but the Removal method is the more accurate.
Advanced	Gives you access to the Advanced menu of Input functions.
Max Mixer Level	Allows you to control the maximum signal level at the mixer. For wide offset (greater than 1 MHz) phase noise measurements, increasing the maximum mixer level towards its compression point maximizes the measurement range.
Input/Output	Displays the basic spectrum analyzer's Input/Output menu. Refer to the <i>PSA Series Reference Guide</i> or the <i>ESA User's Guide</i> for more information.

Marker

Displays a menu that allows you to set each of the four markers to mark, or display, a particular measurement.

- Select Marker** Allows you to select one of the four possible markers. Having selected one of the markers, use the other softkeys on this menu to specify the type of marker or measurement.
- Normal** Sets the specified marker to be a normal marker. That is, it marks the point of the frequency offset that you specify, and then the analyzer measures and displays the phase noise at this point.
- Delta** A delta marker is actually a pair of markers. By pressing **Delta**, you set a pair of markers at your current frequency offset. One of this pair of marker (indicated by an 'R' on the display) is fixed while the second of the pair can be moved using your RPG knob or the numeric keys. The frequency difference and the phase noise difference between these two points is displayed.
- RMS Noise** Displays a second menu allowing access to three RMS noise functions. An RMS Noise marker is actually a pair of markers. By pressing **RMS Noise Degrees**, you set a pair of markers at your current frequency offset. One of this pair of markers (indicated by an 'R' on the display) is fixed while the second of the pair can be moved using your RPG knob or the numeric keys.
- RMS Noise Degrees** The root mean square (RMS) of the phase noise between these two points is calculated, and is displayed in degrees.
- RMS Noise Radians** The root mean square (RMS) of the phase noise between these two points is calculated, and is displayed in radians.
- RMS Noise Jitter** The root mean square (RMS) of the jitter between these two points is calculated, and is displayed in units of time, typically in picoseconds ('ps' or 10^{-12} sec) or femtosecond ('fs' or 10^{-15} sec).
- Residual FM** A Residual FM marker is actually a pair of markers. By pressing **Residual FM**, you set a pair of markers at your current frequency offset. One of this pair of markers (indicated by an 'R' on the display) is fixed while the second of the pair can be moved using your RPG knob or the numeric keys. The root mean square (RMS) of the residual FM between these two points is calculated and displayed.
- Off** Switches the specified marker off.

Marker Trace Allows you to select which of the three traces your currently selected marker is applied to.

Marker Table

Allows you to display all of the data from all of your markers in a tabular form. For every marker you have set, the table will show the number of the trace to which it has been applied, the marker's position on the X axis, and its measured Y axis value. As an aid to interpretation, each marker's trace number is displayed in the same color as the trace itself, that is yellow for Trace 1, cyan blue for trace 2 and magenta pink for trace 3.

On Sets the marker table on. The table is displayed beneath the graticule.

Off Sets the marker table display off.

Marker All Off

Switches all markers off. All markers are removed from the graticule display, and if the marker table is also being displayed, all entries will be removed from it.

Meas Setup

Displays a menu that allows you to enter custom setup parameters for a measurement. The setup menu displayed depends on whether the Monitor Spectrum, Spot Frequency or the Log Plot measurement was selected in the **MEASURE** menu. Some keys are the same as in the basic Spectrum Analyzer mode. Refer to the *PSA Reference Guide* and the *ESA User's Guide* for more information on these keys.

Avg Number Allows you to specify the number of measurements that will be averaged. After the specified number of average counts, the **Avg Mode** setting determines the averaging action. You can also set the averaging function to **On** or **Off**.

On Enables the measurement averaging.

Off Disables the measurement averaging.

Avg Mode Allows you to select the type of termination control used for the averaging function. This determines the averaging action after the specified number of measurements (average count) is reached.

Exp After the average count is reached, each successive data acquisition is exponentially weighted and combined with the existing average.

NOTE PSA Analyzers only: The Exponential average mode is not available when Phase Noise optimization f Mode is On (see [PhNoise Opt f](#)) and the spot frequency offset is between 40 kHz and 60 kHz.

Repeat After the average count is reached, the averaging is reset and a new average is started.

Restore Meas Defaults Sets up the analyzer parameters for the measurement using the factory default analyzer settings. (This only affects measurement parameters for this measurement and does not affect any mode parameters.) If you have made any manual changes to the measurement parameters, restoring the measurement defaults will ensure valid measurements.

Meas Type Provides the menu keys that allow you specify whether you want to measure the **phase noise** of a signal or the **DANL** floor of the analyzer.

Phase Noise Specifies that the analyzer is to measure the phase noise of an input signal.

DANL Floor Specifies that the analyzer's **DANL (Displayed Average Noise Level)** Floor level is to be measured.

Spot Offset Determines the frequency offset at which the phase noise is to be measured.

Table Index The analyzer can hold and display the last 101 phase noise measurements. A subset of 22 of these 101 measurement values can be viewed as a table by selecting the **Numerical** option from the **View/Trace** menu. By specifying the **Table Index**, you can determine which of the measurement results are displayed. Your selected measurement, referred to by its **Table Index** number, is highlighted in yellow.

Advanced Provides access to the Advanced menu of setup functions.

PhNoise Opt f Applies to the PSA series spectrum analyzers only. Used to select the offset frequency (measured relative to the carrier signal) at which the analyzer switches internal filters to make its phase noise measurement. If set to **Auto**, the analyzer will repeat the phase noise measurement with the crossover frequency both above and below your measurement offset, and will display the more accurate of the two measurements. You cannot improve on the measurement's accuracy by setting this to **Manual**, but you can improve the speed of the measurement.

NOTE The analyzer uses one of two different filters when measuring phase noise. One filter gives more accurate results at small offsets, and the other filter is more accurate at larger offsets. You can manually specify whether you wish the crossover point between these two filters to be above or below your measurement offset. If you make two measurements on the same signal, one with the crossover point below your measurement offset and the other one with it above your signal, the lower figure will be the more accurate. The **PhNoise Opt f** softkey only works on PSA analyzers as ESA analyzers use the same internal filter for all measurements.

RBW/Spot Offset The resolution bandwidth is specified as a percentage of the spot offset frequency. This key allows you to specify that percentage figure.

Smoothing Allows you to specify the amount of smoothing done to the trace after the measurement has been performed. The amount of smoothing can be varied between 0.00% and 16.0%. By default, both the trace of the raw data and the smoothed trace are displayed

Filtering Allows you to specify whether or not to apply filtering to the signal. If you do select filtering, there are four levels from which you can select - **none**, **little**, **medium** and **maximum**.

None No filtering is performed. The video bandwidth to resolution bandwidth ratio (VBW/RBW) is fixed at 1.000.

Little A small amount of filtering is performed. The video

	bandwidth to resolution bandwidth ratio (VBW/RBW) is fixed at 0.300.
Medium	A moderate amount of filtering is performed. The video bandwidth to resolution bandwidth ratio (VBW/RBW) is fixed at 0.100.
Maximum	A large amount of filtering is performed. The video bandwidth to resolution bandwidth (VBW/RBW) is fixed at 0.030.
<hr/>	
NOTE	Smoothing is faster than Filtering. However, there is a risk with smoothing that you might hide sudden changes in amplitude that might occur over a very small frequency range.
<hr/>	
Decade Table	Allows you to toggle the Decade Table On and Off . The Decade Table is a table of measurements which shows, for each of the analyzer's three traces (3 max.), the value in dBc/Hz at the point where the traces cross each decade line on the display.
Cancellation	If you have acquired a DANL trace from the analyzer, or a trace taken from a very clean source at the same frequency range that you are measuring, then you can automatically subtract this from your measurement. This softkey displays a submenu allowing you to perform this type of automatic noise cancellation.
	Cancellation Allows you to switch the automatic noise cancellation feature On or Off .
	Ref Trace Allows you to specify which of the three traces holds the reference trace data. This data is automatically subtracted from your phase noise measurement when Cancellation is switched On .
<hr/>	
NOTE	In order for a trace to be used as a Ref Trace , it must be in Reference (View) mode, and must cover the same range of frequencies as those currently being measured.
<hr/>	
	Threshold Allows you to specify the threshold level for noise cancellation. This value represents the minimum difference that must exist at each frequency point between the reference trace and the measured trace for one to be subtracted from the other.

MEASURE

Accesses menu keys that allow you to make Monitor Spectrum, Spot Frequency and Log Plot measurements.

Monitor Spectrum

Displays the frequency spectrum.

Spot Frequency

Measures the phase noise of the input signal at one discrete frequency offset.

Log Plot

Displays a logarithmic plot of the measured phase noise over a range of frequency offsets.

MODE

Accesses menu keys allowing you to select the measurement mode of your analyzer. Additional measurement personality software must be installed and activated in the analyzer for the other mode softkeys to be labeled and functional.

Spectrum Analysis

Accesses the spectrum analyzer menu keys and associated functions.

Phase Noise

Accesses the Phase Noise measurement personality menu keys and associated functions. This allows you to setup and make valid Phase Noise measurements.

NOTE

This menu will have additional entries if other personalities have been installed, for example GSM Option BAH or cdmaOne Option BAC.

Mode Setup

Accesses a menu allowing you to view information about the Phase Noise application and to set the phase noise measurement parameters back to their factory default settings.

Properties

Displays the Phase Noise application version number.

Restore Mode Setup Defaults

Sets up the spectrum analyzer's parameters for the mode using the factory default mode settings.

Preset

Provides a convenient starting point for making most measurements.

Depends on the preset type setting (user, mode, or factory) in the System keys. If the preset type is set to **Factory**, pressing **Preset** results in an immediate analyzer preset to the factory defaults. If it is set to **User**, pressing **Preset** accesses a menu that allows you choose your preset settings from either the factory default values or the settings you have previously defined as the **User** preset state.

- User Preset** Restores the analyzer to a user defined state. The state was defined from the System menu when the Power On/Preset function was selected and Save User Preset was pressed. If you did not save a user state, then the current power-up state is stored as the user preset file for use when Preset is pressed.
- Factory Preset** A full factory preset is executed so the analyzer is returned to the factory default state. The preset type can be set to **Factory** from the **Power On/Preset** function in the System menu.
- Mode Preset** Restores the mode defaults of the current mode, or of the mode that was in use when the analyzer was turned off or powered down. See the *PSA Series Reference Guide* or the *ESA User's Guide* for more details.

SPAN X Scale

Start Offset	Allows you to specify the offset frequency at which your Log Plot measurement will start.
Stop Offset	Allows you to specify the offset frequency at which your Log Plot measurement will stop.
Scale/Div	Although the Spot Frequency display appears to be showing a continuously moving plot, it is actually made up of a number of discrete individual measurements plotted over time. This softkey allows you to specify how many measurements will be plotted between each successive division on the graticule.
NOTE	Scale/Div affects both the phase noise display and the delta freq display simultaneously.
Ref Value	This applies to the Spot Frequency measurement only. The analyzer stores up to 101 measurement values which it updates continually. These values are then used to generate the plot on the screen. If you are displaying fewer than the full 101 measurements (in other words, you have set Scale/Div (above) to less than 10), you can use this softkey to specify the measurement number with which your display is to start.
NOTE	Ref Value affects both the phase noise display and the delta freq display simultaneously.

Sweep Menu

- Sweep Time** Allows you to specify the sweep time for your measurement or to let the analyzer set it automatically. This is grayed out in Log Plot measurements as the best setting is automatically calculated for each linear segment.
- Sweep** Specifies whether the analyzer sweeps (or measures) continually, or whether it performs a single sweep and then stops.
- Single** The analyzer performs one single measurement and then stops. You have to press the **Restart** button every time you want to make another measurement.
 - Cont** The analyzer continuously measures the signal it is receiving and repeatedly updates the plots and the measurements.
- Points** Allows you to specify the number of data points used to generate the display (ESA analyzers only).

Trace/View

Accesses the view menu keys that allow you to set the way measurement result information is displayed. The menu options will vary depending on the measurement that is selected under the **Measure** menu.

Graphical	Measurement data is displayed graphically, and only the most recent measurement value is displayed numerically. If signal tracking has been switched on, a graphical display of the change in frequency is shown alongside the phase noise plot.																		
Numerical	A subset of 22 of the 101 measurements is shown in a table to the left of the display. The phase noise plot is still shown, but the delta frequency display is removed, regardless of whether signal tracking is switched on or off.																		
Trace	Allows you to select any of the three traces to then specify its characteristics.																		
Raw	The trace selected in Trace (above) records and displays the raw measurement data.																		
Smoothed	The trace selected in Trace (above) records and displays the smoothed measurement data.																		
Reference (View)	The trace selected in Trace (above) is set to Reference (View) . You can see its display on the screen. Trace 1 displays in yellow, Trace 2 in cyan blue, and Trace 3 in magenta pink.																		
Blank	The trace selected in Trace (above) is blanked out on the screen so you can no longer see it.																		
Operations	Selects a menu allowing you to move data between traces. <table><tr><td>1 -> 2</td><td>Copies the data in Trace 1 to Trace 2.</td></tr><tr><td>1 -> 3</td><td>Copies the data in Trace 1 to Trace 3.</td></tr><tr><td>2 -> 1</td><td>Copies the data in Trace 2 to Trace 1.</td></tr><tr><td>2 -> 3</td><td>Copies the data in Trace 2 to Trace 3.</td></tr><tr><td>3 -> 1</td><td>Copies the data in Trace 3 to Trace 1.</td></tr><tr><td>3 -> 2</td><td>Copies the data in Trace 3 to Trace 2.</td></tr><tr><td>1 <-> 2</td><td>Swaps the data in Trace 1 and Trace 2.</td></tr><tr><td>1 <-> 3</td><td>Swaps the data in Trace 1 and Trace 3.</td></tr><tr><td>2 <-> 3</td><td>Swaps the data in Trace 2 and Trace 3.</td></tr></table>	1 -> 2	Copies the data in Trace 1 to Trace 2.	1 -> 3	Copies the data in Trace 1 to Trace 3.	2 -> 1	Copies the data in Trace 2 to Trace 1.	2 -> 3	Copies the data in Trace 2 to Trace 3.	3 -> 1	Copies the data in Trace 3 to Trace 1.	3 -> 2	Copies the data in Trace 3 to Trace 2.	1 <-> 2	Swaps the data in Trace 1 and Trace 2.	1 <-> 3	Swaps the data in Trace 1 and Trace 3.	2 <-> 3	Swaps the data in Trace 2 and Trace 3.
1 -> 2	Copies the data in Trace 1 to Trace 2.																		
1 -> 3	Copies the data in Trace 1 to Trace 3.																		
2 -> 1	Copies the data in Trace 2 to Trace 1.																		
2 -> 3	Copies the data in Trace 2 to Trace 3.																		
3 -> 1	Copies the data in Trace 3 to Trace 1.																		
3 -> 2	Copies the data in Trace 3 to Trace 2.																		
1 <-> 2	Swaps the data in Trace 1 and Trace 2.																		
1 <-> 3	Swaps the data in Trace 1 and Trace 3.																		
2 <-> 3	Swaps the data in Trace 2 and Trace 3.																		

NOTE When data is stored in a trace, that trace is set to **Reference (View)** mode.

Load/Save Accesses a menu allowing you to load stored trace data to the analyzer, and to save trace data to files.

Trace Specifies which of the three traces you wish to save or load.

Drive Specifies which drive (that is, which disk) you wish to load data from or store data to. 'Drive A:' is a floppy disk and 'C:' is the analyzer's hard disk.

Filename Displays the alphabetic editor allowing you to specify the name of the file that you wish to load or save. The file extension .LPT is automatically added to the name you type.

Save Trace Saves the trace that you selected to the filename and drive (disk) that you specified. The filename has the extension .LPT added automatically.

Load Trace Takes the filename from the drive (disk) that you specified, and loads the data into the trace that you have selected.

5 Language Reference

These commands are only available when the Phase Noise mode has been selected using analyzer :SElect or analyzer :NSElect. If the Phase Noise mode is selected, commands that are unique to another mode are not available.

CALCulate Subsystem

This subsystem is used to perform post-acquisition data processing. In effect, the collection of new data triggers the CALCulate subsystem. In this instrument, the primary functions in this subsystem are markers and limits.

The SCPI default for data output format is ASCII. The format can be changed to binary with FORMat:DATA which transports faster over the bus.

CALCulate:LPLot Subsystem

The Log Plot measurement shows a graph of the phase noise power plotted against the log of the frequency offset from the carrier.

Decade Table On/Off

```
:CALCulate:LPLot:DECade:TABLE[:STATe] OFF|ON|0|1
```

```
:CALCulate:LPLot:DECade:TABLE[:STATe] ?
```

The decade table shows the measured values for each plot at every point where the trace(s) cross(es) a decade line on the display. This command turns the decade table display on or off.

Example: `CALC:LPLot:DEC:TABLE ON`

Remarks: The LPLot keyword must be specified in the command.

Front Panel

Access: **Marker, More, Decade Table**

Copy Trace A to Trace B

```
:CALCulate:LPLot:TRACe:COPIY[A] [B]
```

Copies the contents of one trace [A] to another trace [B].

Remarks: There are no spaces in the command. In other words, `:COPY12` is a valid command that would copy Trace 1 to Trace 2. `:COPY1 2` would be invalid as it contains a space.

Front Panel

Access: **View/Trace, Menu 1 of 2, Operations**

Trace Mode

```
:CALCulate:LPLot:TRACe[1] | 2 | 3:MODE RAW|SMOothed|VIEW|BLANK
```

```
:CALCulate:LPLot:TRACe[1] | 2 | 3:MODE?
```

This determines the type of trace stored and displayed in the selected trace.

Factory Preset: Trace 1: Raw

Trace 2: Smoothed

Trace 3: Blank

Range: Raw, Smoothed, View or Blank

Front Panel

Access: **Trace, Trace[1|2|3], Raw|Smoothed|View|Blank**

Swap Trace A and Trace B

`:CALCulate:LPLot:TRACe:SWAP [A] [B]`

Swaps the contents of two traces, [A] and [B]. Trace [A] data moves to Trace [B], while Trace [B] data moves to Trace [A].

Remarks: There are no spaces in the command. In other words, `:SWAP12` is a valid command that would swap Trace 1 to Trace 2 data. `:SWAP1 2` would be invalid as it contains a space.

Front Panel

Access: **View/Trace, Menu 1 of 2, Operations**

CALCulate:MARKers Subsystem

Marker Mode

```
:CALCulate:LPLot:MARKer [1] | 2 | 3 | 4 :MODE
POSITION | DELTa | RMSDegree | RMSRadian | RFM
| RMSJitter | OFF
:CALCulate:LPLot:MARKer [1] | 2 | 3 | 4 :MODE?
```

This command specifies the calculation mode for each of the four markers.

- **POSITION** - Sets the specified marker to be a 'normal' marker. That is, it measures the phase noise at your specified frequency offset.
- **DELTA** - Sets the specified marker to measure the difference in frequency between the first and the second marker.
- **RMSDegree** - Sets the specified marker to measure the RMS of the phase noise between the first and the second marker. The result is displayed in degrees.
- **RMSRadian** - Sets the specified marker to measure the RMS of the phase noise between the first and the second marker. The result is displayed in radians.
- **RFM** - Sets the specified marker to measure the RMS of the residual FM between the first and the second marker. The result is displayed in Hertz.
- **RMSJitter** - Sets the specified marker to measure the RMS of the jitter between the first and the second marker. The result is displayed in units of time.
- **OFF** - Sets the marker off

Example: `CALC:LPLot:MARK:MODE RMSD`

Remarks: The LPLot keyword must be specified in the command.

Front Panel

Access: **Marker**

Marker Table On/Off

```
:CALCulate:LPLot:MARKer:TABLE [:STATe] OFF | ON | 0 | 1
:CALCulate:LPLot:MARKer:TABLE [:STATe] ?
```

Turns the marker table display on or off.

Example: `CALC:LPLot:MARK:TABLE ON`

Remarks: The LPLot keyword must be specified in the command.

Front Panel

Access: **Marker, More 1 of 2, Marker Table**

Marker Trace

`:CALCulate:LPLot:MARKer[1] | 2 | 3 | 4:TRACe <tracenum>`

`:CALCulate:LPLot:MARKer[1] | 2 | 3 | 4:TRACe?`

This command specifies the trace on which the specified marker will be placed.

Example: `CALC:LPLot:MARK:TRAC 3`

Remarks: The LPLot keyword must be specified in the command.

Front Panel

Access: **Marker, Select Marker, Marker Trace**

Marker X Value

`:CALCulate:LPLot:MARKer[1] | 2 | 3 | 4:X <number>`

`:CALCulate:LPLot:MARKer[1] | 2 | 3 | 4:X?`

This command positions the selected marker at the specified position on the X-axis.

Range: Graph Start Offset and Stop Offset frequencies.

Factory Preset: All four markers are preset to 10 kHz

Example: `CALC:LPLot:MARK:X 2.5 MHz`

Front Panel

Access: **Marker**

Marker Y Value

`:CALCulate:LPLot:MARKer[1] | 2 | 3 | 4:Y?`

This command queries and returns the current Y value for the selected marker. The value is returned in the Y-axis units of the current trace (typically dBc/Hz).

Range: -200.0 to 200.0 dBc/Hz, dB/Hz, Radians or Degrees, depending on the type of marker.

Example: `CALC:LPLot:MARK3:Y?`

Front Panel

Access: **Marker**

CONFigure Subsystem

The CONFigure commands are used with several other commands to control the measurement process. The full set of commands are described in the section “MEASure Group of Commands” on page 115.

Selecting measurements with the CONFigure/FETCh/MEASure/READ commands sets the instrument state to the defaults for that measurement and to make a single measurement. Other commands are available for each measurement to allow you to change: settings, view, limits, etc. Refer to:

SENSE:<measurement>, SENSE:CHANnel, SENSE:CORRection,
SENSE:DEFaults, SENSE:DEViation, SENSE:FREQuency,
SENSE:PACKet, SENSE:POWer, SENSE:RADio, SENSE:SYNC
CALCulate:<measurement>, CALCulate:CLIMits
DISPlay:<measurement>
TRIGger

The INITiate[:IMMediate] or INITiate:REStart commands will initiate the taking of measurement data without resetting any of the measurement settings that you have changed from their defaults.

Configure the Selected Measurement

:CONFigure:<measurement>

A CONFigure command must specify the desired measurement. It will set the instrument settings for that measurement's standard defaults, but should not initiate the taking of data. The available measurements are described in the MEASure subsystem.

NOTE

PSA analyzers only

If CONFigure initiates the taking of data, the data should be ignored. Other SCPI commands can be processed immediately after sending CONFigure. You do not need to wait for the CONF command to complete this 'false' data acquisition.

Configure Query

:CONFigure?

The CONFigure query returns the name of the current measurement.

DISPlay Subsystem

The DISPlay controls the selection and presentation of textual, graphical, and TRACe information. Within a DISPlay, information may be separated into individual WINDows.

Set the Display Line

```
:DISPlay:MONitor:WINDow:TRACe:Y:DLINe <ampl>
```

```
:DISPlay:MONitor:WINDow:TRACe:Y:DLINe?
```

Defines the level of the display line, in the active amplitude units if no units are specified.

Factory Preset: 2.5 divisions below the reference level

Range: 10 display divisions below the reference level to the reference level

Default Unit: Current active units

Front Panel

Access: Display, Display Line

Control the Display Line

```
:DISPlay:MONitor:WINDow:TRACe:Y:DLINe:STATe OFF|ON|0|1
```

```
:DISPlay:MONitor:WINDow:TRACe:Y:DLINe:STATe?
```

Turns the display line on or off.

Factory Preset: Off

Front Panel

Access: Display, Display Line

FETCh Subsystem

The FETCh? queries are used with several other commands to control the measurement process. These commands are described in the section on the “[MEASure Group of Commands](#)” on page 115. These commands apply only to measurements found in the MEASURE menu.

This command puts selected data from the most recent measurement into the output buffer (new data is initiated/measured). Use FETCh if you have already made a good measurement and you want to look at several types of data (different [n] values) from the single measurement. FETCh saves you the time of re-making the measurement. You can only fetch results from the measurement that is currently active.

If you need to make a new measurement, use the READ command, which is equivalent to an INITiate[:IMMediate] followed by a FETCh.

:FETCh <meas>? will return valid data only when the measurement is in one of the following states:

- idle
- initiated
- paused

Fetch the Current Measurement Results

:FETCh: <measurement> [n] ?

A FETCh? command must specify the desired measurement. It will return the valid results that are currently available, but will not initiate the taking of any new data. You can only fetch results from the measurement that is currently selected. The code number n selects the kind of results that will be returned. The available measurements and data results are described in the “[MEASure Group of Commands](#)” on page 115.

FORMat Subsystem

The FORMat subsystem sets a data format for transferring numeric and array information.

Measurement Results format

`:FORMat:MEASure[:DATA] ASCii|REAL32`

`:FORMat:MEASure[:DATA]?`

This command controls the format of measurement data that is transferred to a remote user. The REAL and ASCII formats will format trace data in the current amplitude units.

ASCII - Amplitude values are in ASCII, in amplitude units, separated by commas. ASCII format requires more memory than the binary formats. Therefore, handling large amounts of this type of data, will take more time and storage space.

Real32 - Binary 32-bit real values in amplitude unit, in a definite length block. Transfers of real data are done in a binary block format.

A definite length block of data starts with an ASCII header that begins with # and indicates how many additional data points are following in the block. Suppose the header is #512320.

- The first digit in the header (5) tells you how many additional digits/bytes there are in the header.
- The 12320 means 12 thousand, 3 hundred, 20 data bytes follow the header.
- Divide this number of bytes by your selected data format bytes/point, that is divide by 4 for real32. In this example, if you are using real32 then there are 3080 points in the block.

Factory Preset: ASCII

Front Panel Access: Not Applicable. This is a remote command only.

INITiate Subsystem

The INITiate subsystem is used to start a trigger for a measurement. These commands only initiate measurements from the MEASURE front panel key or the “[MEASure Group of Commands](#)” on page 115. Refer also to the TRIGger and ABORt subsystems for related commands.

Take New Data Acquisition for Selected Measurement

`:INITiate:<measurement>`

This command initiates a trigger cycle for the measurement specified, but does not return data. The valid measurement names are described in the MEASure subsystem.

If your selected measurement is not currently active, the instrument will change to the measurement in your INIT:<meas> command and initiate a trigger/measurement cycle.

This command is not available for the one-button measurements in the Spectrum Analysis mode.

Example: INIT:ACP

INSTRUMENT Subsystem

This subsystem includes commands for querying and selecting instrument measurement (personality option) modes.

Select Application by Number

`:INSTRument:NSElect <integer>`

`:INSTRument:NSElect?`

Select the measurement mode by its instrument number. The actual available choices depends upon which applications are installed in the instrument.

ESA analyzers only

- 1 = SA
- 3 = GSM
- 4 = CDMA (cdmaOne)
- 14 = PNOISE (Phase Noise)
- 202 = GSM EDGE
- 228 = BLUETOOTH

PSA analyzers only

- 1 = SA
- 4 = CDMA (cdmaOne)
- 5 = NADC
- 6 = PDC
- 8 = BASIC
- 9 = WCDMA (3GPP)
- 10 = CDMA2K (cdma2000)
- 13 = EDGE GSM
- 14 = PNOISE (phase noise)

NOTE

If you are using the SCPI status registers and the analyzer mode is changed, the status bits should be read, and any errors resolved, prior to switching modes. Error conditions that exist prior to switching modes cannot be detected using the condition registers after the mode change. This is true unless they recur after the mode change, although transitions of these conditions can be detected using the event registers.

Changing modes resets all SCPI status registers and mask registers to their power-on defaults. Hence, any event or condition register masks must be re-established after a mode change. Also note that the power up status bit is set by any mode change, since that is the default state

after power up.

Example: INST:NSEL 4

Factory Preset: Persistent state with factory default of 1

Range: 1 to x, where x depends upon which applications are installed.

Front Panel

Access: Mode

Select Application

ESA Series:

```
:INSTRument [:SElect]
  'SA' | 'GSM' | 'CDMA' | 'PNOISE' | 'BLUETOOTH' | 'EDGE'
```

PSA Series:

```
:INSTRument [:SElect]
SA | PNOISE | BASIC | CDMA | CDMA2K | EDGE GSM | NADC | PDC | WCDMA

:INSTRument [:SElect] ?
```

Select the measurement mode. The actual available choices depend upon which modes (measurement applications) are installed in the instrument. A list of the valid choices is returned with the INST:CAT? query.

Once an instrument mode is selected, only the commands that are valid for that mode can be executed.

- 1 = SA (PSA analyzers only)
- 4 = CDMA (cdmaOne)
- 5 = NADC
- 6 = PDC
- 8 = BASIC
- 9 = WCDMA (3GPP)
- 10 = CDMA2K (cdma2000)
- 13 = EDGE GSM
- 14 = PNOISE (phase noise)

NOTE

If you are using the status bits and the analyzer mode is changed, the status bits should be read, and any errors resolved, prior to switching modes. Error conditions that exist prior to switching modes cannot be detected using the condition registers after the mode change. This is true unless they recur after the mode change, although transitions of these conditions can be detected using the event registers.

Changing modes resets all SCPI status registers and mask registers to

their power-on defaults. Hence, any event or condition register masks must be re-established after a mode change. Also note that the power up status bit is set by any mode change, since that is the default state after power up.

Example: ESA Series analyzers: INST:SEL 'CDMA'

Example: PSA Series analyzers: INST:SEL CDMA

Factory Preset: Persistent state with factory default of Spectrum Analyzer mode.

Front Panel

Access: **Mode**

MEASure Group of Commands

This group includes the CONFigure, FETCh, MEASure, and READ commands that are used to make measurements and return results. The different commands can be used to provide fine control of the overall measurement process, like changing measurement parameters from their default settings. Most measurements should be done in single measurement mode, rather than measuring continuously.

PSA analyzers only

The SCPI default for the format of any data output is ASCII. The format can be changed to binary with FORMat:MEASure:DATA which transports faster over the bus.

CONFigure, FETCh, MEASure, READ Interactions

These commands are all inter-related. See [Figure 5-1 on page 116](#).

Measure Commands

`:MEASure:<measurement> [n] ?`

This is a fast single-command way to make a measurement using the factory default instrument settings. These are the settings and units that conform to the Mode Setup settings (e.g. radio standard) that you have currently selected.

- Stops the current measurement (if any) and sets up the instrument for the specified measurement using the factory defaults.
- Initiates the data acquisition for the measurement.
- Blocks other SCPI communication, waiting until the measurement is complete before returning results.
- If the function does averaging, it is turned on and the number of averages is set to 10 (ESA analyzers only).
- After the data is valid it returns the scalar results, or the trace data, for the specified measurement. The type of data returned may be defined by an [n] value that is sent with the command.

The scalar measurement results will be returned if the optional [n] value is not included, or is set to 1. If the [n] value is set to a value other than 1, the selected trace data results will be returned. See each command for details of what types of scalar results or trace data results are available.

ASCII is the default format for the data output. The binary data formats should be used for handling large blocks of data since they are smaller and faster than the ASCII format. Refer to the

FORMat:DATA command for more information.

If you need to change some of the measurement parameters from the factory default settings you can set up the measurement with the CONFigure command. Use the commands in the SENSE:<measurement> and CALCulate:<measurement> subsystems to change the settings. Then you can use the READ? command to initiate the measurement and query the results. See Figure 5-1.

If you need to repeatedly make a given measurement with settings other than the factory defaults, you can use the commands in the SENSE:<measurement> and CALCulate:<measurement> subsystems to set up the measurement. Then use the READ? command to initiate the measurement and query results.

Measurement settings persist if you initiate a different measurement and then return to a previous one. Use READ:<measurement>? if you want to use those persistent settings. If you want to go back to the default settings, use MEASure:<measurement>?.

Figure 5-1 Measurement Group of Commands

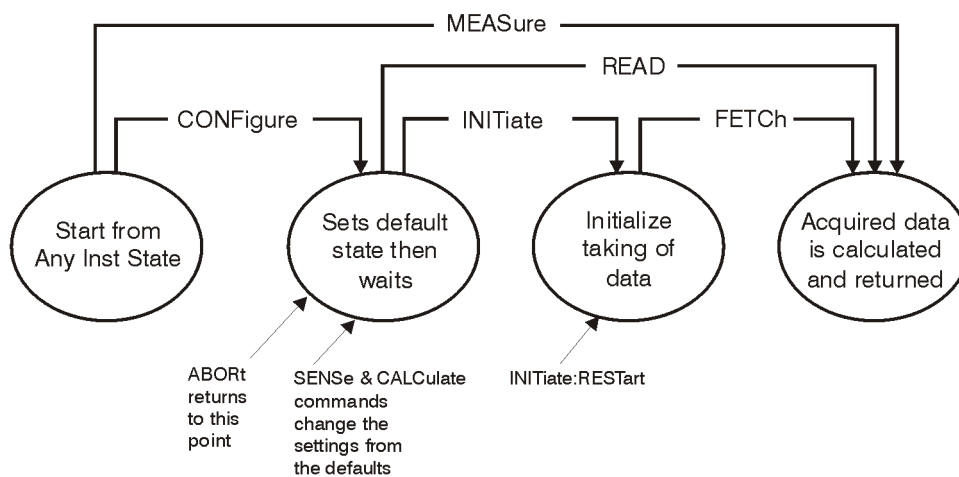

Configure Commands

:CONFigure:<measurement>

This command stops the current measurement (if any) and sets up the instrument for the specified measurement using the factory default instrument settings. It sets the instrument to single measurement mode but should not initiate the taking of measurement data unless INIT:CONTinuous is ON. After you change any measurement settings, the READ command can be used to initiate a measurement without changing the settings back to their defaults. On ESA analyzers, the CONFigure command also turns the averaging function on and sets the

number of averages to 10 for all measurements.

The CONFigure? query returns the current measurement name.

Fetch Commands

:FETCh: <measurement> [n] ?

This command puts selected data from the most recent measurement into the output buffer. Use FETCh if you have already made a good measurement and you want to return several types of data (different [n] values, e.g. both scalars and trace data) from a single measurement. FETCh saves you the time of re-making the measurement. You can only FETCh results from the measurement that is currently active, it will not change to a different measurement.

If you need to get new measurement data, use the READ command, which is equivalent to an INITiate followed by a FETCh.

The scalar measurement results will be returned if the optional [n] value is not included, or is set to 1. If the [n] value is set to a value other than 1, the selected trace data results will be returned. See each command for details of what types of scalar results or trace data results are available. The binary data formats should be used for handling large blocks of data since they are smaller and transfer faster than the ASCII format. (FORMat:DATA)

FETCh may be used to return results other than those specified with the original READ or MEASure command that you sent.

Read Commands

:READ: <measurement> [n] ?

- Does not preset the measurement to the factory default settings. For example, if you have previously initiated the ACP measurement and you send READ:ACP? it will initiate a new measurement using the same instrument settings.
- Initiates the measurement and puts valid data into the output buffer. If a measurement other than the current one is specified, the instrument will switch to that measurement before it initiates the measurement and returns results.

For example, suppose you have previously initiated the ACP measurement, but now you are running the channel power measurement. Then you send READ:ACP? It will change from channel power back to ACP and, using the previous ACP settings, will initiate the measurement and return results.

- Blocks other SCPI communication, waiting until the measurement is complete before returning the results.

If the optional [n] value is not included, or is set to 1, the scalar measurement results will be returned. If the [n] value is set to a value other than 1, the selected trace data results will be returned. See each command for details of what types of scalar results or trace data results are available. The binary data formats should be used when handling large blocks of data since they are smaller and faster than the ASCII format. (FORMat:DATA)

Phase Noise Log Plot Measurement

This measures the phase noise of a signal at a specified frequency range offset from the main carrier signal. The results are plotted on a graph of phase noise power against the log of the offset frequency. You must be in the Phase Noise mode to use this command. Use INSTRument:SElect to set the mode.

The general functionality of CONFigure, FETCh, MEASure, and READ are described at the beginning of this section. See the SENSE:LPLot commands for more measurement related commands.

:FETCh:LPLot [n] ?

:READ:LPLot [n] ?

:MEASure:LPLot [n] ?

Front Panel

Access: **Measure, Log Plot**

After the measurement is selected, press
Restore Meas Defaults to restore factory defaults.

Measurement Results Available

n	Results Returned
0	No return value.
not specified or n=1	Returns seven comma-separated scalar values corresponding to the following measurement results: <ol style="list-style-type: none"> 1. Carrier Power (dBm) 2. Carrier Frequency (Hz) 3. RMS Phase Noise over the entire smoothed trace (degrees) 4. RMS Phase Noise over the entire smoothed trace (radians) 5. Residual FM over the entire smoothed trace (Hz) 6. Spot Noise at the Start Offset Frequency (dBc/Hz) 7. Spot Noise at the Stop Offset Frequency (dBc/Hz)
n=2	Returns three comma-separated scalar values corresponding to the following measurement values: <ol style="list-style-type: none"> 1. Number of x/y value pairs in Trace 1 2. Number of x/y value pairs in Trace 2 3. Number of x/y value pairs in Trace 3

n	Results Returned
n=3	Returns a comma-separated list of the data points from Trace 1. The number of data points in the trace depends on the implementation and the frequency range being measured. This can be found by using the :LPLLOT2? command (above):
n=4	Returns a comma-separated list of the data points from Trace 2. The number of data points in the trace depends on the implementation and the frequency range being measured. This can be found by using the :LPLLOT2? command (above):
n=5	Returns a comma-separated list of the data points from Trace 3. The number of data points in the trace depends on the implementation and the frequency range being measured. This can be found by using the :LPLLOT3? command (above):
n=6	Returns a comma-separated list of the data points which represent the values found on each trace at each decade offset frequency. The points in the list are returned in the following order: Frequency Offset, Trace number 1 (yellow) amplitude, Trace number 2 (cyan blue) amplitude and Trace number 3 (magenta pink) amplitude. Any data points that do not have an associated trace, or any data points that not covered by a particular frequency will return SCPI_NAN. The total number of values listed can be calculated by multiplying the number of decades by 4, and adding 4.

Monitor Spectrum

This measures the power levels across the specified spectral band using one of three traces. By default, the analyzer's entire range is measured.

The general functionality of **CONFigure**, **FETCh**, **MEASure**, and **READ** are described at the beginning of this section. See the **SENSe:MONitor** commands for more measurement related commands.

:CONFigure:MONitor

:FETCh:MONitor [n]

:READ:MONitor [n]

:MEASure:MONitor [n]

Front Panel

Access: **Measure, Monitor Band/Channel**

After the measurement is selected, press
Restore Meas Defaults to restore factory defaults.

Measurement Results Available

n	Results Returned
not specified or n=1	Trace 1 data
2	Trace 2 data
3	Trace 3 data

Phase Noise Spot Frequency Measurement

This measures the phase noise of a signal at a specified frequency offset from the main carrier signal. You must be in the Phase Noise mode to use this command. Use INSTRument:SElect to set the mode.

The general functionality of CONFigure, FETCh, MEASure, and READ are described at the beginning of this section. See the SENSE:SFrequency commands for more measurement related commands.

:FETCh:SFrequency [n] ?

:READ:SFrequency [n] ?

:MEASure:SFrequency [n] ?

Front Panel

Access: **Measure, Spot Frequency**

After the measurement is selected, press **Restore Meas Defaults** to restore factory defaults.

Measurement Results Available

n	Results Returned
0	No return value.
not specified or n=1	Returns six comma-separated scalar values corresponding to the following measurement results: <ol style="list-style-type: none"> 1. Carrier Power (dBm) 2. Carrier Frequency (Hz) 3. Initial carrier frequency (Hz) 4. Carrier frequency delta (Hz) 5. Upper or right SSB (Single Side Band) noise (dBc/Hz) 6. Average SSB (Single Side Band) noise (dBc/Hz)
n=2	Returns 101 comma-separated scalar values representing a trail of the measured phase noise of the carrier signal.
n=3	Returns 101 comma-separated scalar values representing a trail of the measured carrier frequencies.
n=4	Returns 101 comma-separated scalar values representing a trail of the measured carrier powers.

MMEMemory Subsystem

The purpose of the MMEMemory subsystem is to provide access to mass storage devices such as internal or external disk drives. If mass storage is not specified in the filename, the default mass storage specified in the MSIS command will be used.

NOTE

Refer also to :CALCulate and :TRACe subsystems for more trace and limit line commands (*ESA analyzers only*).

Agilent ESA analyzers use two types of mass storage devices:

- 3.5 inch disk drive (high density, 1.44 MBytes formatted) designated “A:”
- Part of flash memory and treated as a device designated “C:”

The MMEMemory command syntax term <file_name> is a specifier having the form: drive:name.ext, where the following rules apply:

- “drive” is “A:” or “C:”
- “name” is a DOS file name of up to eight characters, letters (A-Z, a-z) and numbers (0-9) only (lower case letters are read as uppercase)
- “ext” is an optional file extension using the same rules as “name,” but consists of up to three characters total. (The default file extension will be added if it is not specified.)

Load a Log Plot Reference Trace from Disk

```
:MMEMemory:LPLot:LOAD:TRACe <tracenum>,<filename>
```

```
:MMEMemory:LPLot:LOAD:TRACe <tracenum>,<filename>
```

Loads the contents of a data file to one of the traces. You must specify the complete file name and path, for example A:\mytrace.lpt.

Example: :MMEMemory:LPLot:LOAD:TRAC 2,“C:MYTRACE.lpt”

Remarks: See also the command
 MMEMemory:LPLot:STORe:TRACe<tracenum>,<filename>
 e>

Front Panel

Access: View/Trace, More 1 of 2, Load/Save, Drive

View/Trace, More 1 of 2, Load/Save, Filename

View/Trace, More 1 of 2, Load/Save, Load Trace

Remarks: Three separate actions have to be performed when using the front panel keys to save a file. First the drive

has to be specified. Then the file name has to be specified. Finally you have to use the Load Trace softkey to load the data to your specified trace.

The two options when specifying the drive are A: (a standard floppy disk) or C: (the analyzer's internal memory).

Store a Log Plot Reference Trace to Disk

```
:MMEMory:LPLot:STORe:TRACe <tracenum>,<filename>
```

```
:MMEMory:LPLot:STORe:TRACe <tracenum>,<filename>
```

Stores the contents of one of the traces to disk or to the analyzer's own internal file system for loading at a later time. You must specify the complete file name and path, for example A:\mytrace.lpt.

Example: :MMEM:LPL:STOR:TRAC 2,"C:MYTRACE.LPT"

Remarks: See also the command
 :MMEMory:LPLot:LOAD:TRACe<tracenum>,
 filename>

Front Panel

Access: **View/Trace, More 1 of 2, Load/Save, Drive**
View/Trace, More 1 of 2, Load/Save, Filename
View/Trace, More 1 of 2, Load/Save, Save Trace

Remarks: Three separate actions have to be performed when using the front panel keys to save a file. First the volume has to be specified. Then the file name has to be specified. Finally you have to use the Save Trace softkey to save the data to your specified file.

The two options when specifying the volume are A: (a standard floppy disk) or C: (the instrument's internal memory).

READ Subsystem

The READ? commands are used with several other commands and are documented in the section on the [“MEASure Group of Commands” on page 115](#).

Initiate and Read Measurement Data

`:READ:<measurement> [n] ?`

A READ? query must specify the desired measurement. It will cause a measurement to occur without changing any of the current settings and will return any valid results. The code number *n* selects the kind of results that will be returned. The available measurements and data results are described in the [“MEASure Group of Commands” on page 115](#).

SENSe Subsystem

These commands are used to set the analyzer state parameters so that you can measure a particular input signal. Some SENSe commands are only for use with specific measurements found under the MEASURE key menu or the [“MEASure Group of Commands” on page 115](#). The measurement must be active before you can use these commands.

The SCPI default for the format of any data output is ASCII. The format can be changed to binary with FORMat:DATA which transports faster over the bus.

Display Average Noise Level—Measurement Method

`[:SENSe] :DANL :METHod ATTenuator | REMoval`

`[:SENSe] :DANL :METHod?`

Specifies which of the two possible methods of measuring DANL is to be used. Setting the Mode to Attenuator causes the analyzer to attenuate any input signal to such a degree that it disappears into the background noise. The noise level can then be measured. Setting the Mode to Removal requires that the input cable be physically disconnected from the analyzer before the measurement is made.

Factory Preset: Attenuator

Remarks: Removal is the more accurate method of measuring DANL, but Attenuator is generally more convenient and is suitable for most purposes.

Front Panel

Access: Input/Output, DANL Method

Default Reset

`[:SENSe] :DEFaults`

Restores personality Mode Setup defaults.

Front Panel

Access: Mode Setup

Remarks: This command sets all the SENSe defaults but has no effect on the MEASure default settings. Use the `CONFigure:<measurement>` command to set measurement defaults.

Frequency Commands

Carrier Frequency

`[:SENSe] :FREQuency:CARRier <freq>`

`[:SENSe] :FREQuency:CARRier?`

Specifies the frequency of the carrier.

Factory Preset: 50 MHz

Range: ESA E4401B: 9 kHza to 1.58 GHz
 ESA E4402B: 9 kHza to 3.10 GHz
 ESA E4404B: 9 kHza to 6.78 GHz
 ESA E4405B: 9 kHza to 13.3 GHz
 ESA E4407B: 9 kHza to 27.0 GHz
 PSA E4443A: 3 Hz to 6.78 GHz
 PSA E4445A: 3 Hz to 13.3 GHz
 PSA E4440A: 3 Hz to 27.0 GHz
 a 100 Hz with Option UKB

Front Panel

Access: **FREQUENCY/Channel**

Carrier Search

`[:SENSe] :FREQuency:CARRier:SEARch`

Automatically searches for and tunes to the strongest signal within the currently specified search span.

Front Panel

Access: **FREQUENCY/Channel**

Remarks: When Search Span is set to Auto, the analyzer searches the entire spectrum above 100 Hz. When Search Span is set to manual, the search is limited to the currently specified frequency span centered on the current carrier frequency.

Search Span Automatic

```
[ :SENSe ] :FREQUency :CARRier :SEARch :AUTO ON | OFF | 1 | 0
```

```
[ :SENSe ] :FREQUency :CARRier :SEARch :AUTO ?
```

Specifies whether automatic setting of the frequency span is set to On or Off. When Search Auto is set to On, the analyzer searches the entire spectrum above 100 Hz. When Search Auto is set to Off, the search is limited to the currently specified frequency span centered on the current carrier frequency.

Factory Preset: On

Front Panel

Access: **FREQUENCY/Channel**

Search Span

```
[ :SENSe ] :FREQUency :CARRier :SEARch :SPAN <freq>
```

```
[ :SENSe ] :FREQUency :CARRier :SEARch :SPAN ?
```

Specifies the frequency range within which the analyzer will search for a carrier wave.

Factory Preset: 10 kHz

Range: 100 Hz to 200 MHz

Remarks: This is only applicable when automatic search span ([:SENSe] :FREQUency :CARRier :SEARch :AUTO) is set to Off.

Front Panel

Access: **FREQUENCY/Channel**

Signal Tracking

```
[ :SENSe ] :FREQUency :CARRier :TRACk [ :STATe ] OFF | ON | 1 | 0
```

```
[ :SENSe ] :FREQUency :CARRier :TRACk [ :STATe ] ?
```

Specifies whether or not the analyzer tracks a slowly drifting signal. When signal tracking is Off, the analyzer measures at a fixed frequency. When signal tracking is On, the analyzer repeatedly measures the frequency of the carrier signal to check for any change that might have occurred, and retunes to the new frequency if necessary.

Factory Preset: Off

Remarks: The repeated realignment of the carrier signal when signal tracking is On causes measurements to take longer than when signal tracking is Off.

Front Panel

Access: **FREQUENCY/Channel**

Signal Tracking Drift Span

`[:SENSe] :FREQuency:CARRier:TRACk:DSPan <value>`

`[:SENSe] :FREQuency:CARRier:TRACk:DSPan?`

Specifies the span, as a percentage of the carrier frequency, within which the frequency drift will be measured. For example, if a drift span of 12% is specified, the signal will be tracked as long as it remains within plus or minus 6% of the most recent frequency measurement.

Factory Preset: 10%

Range: 10% to 25%

Remarks: Only available when signal tracking is On and the Spot Frequency measurement is running.

Front Panel

Access: **FREQUENCY/Channel**

Signal Tracking Interval

`[:SENSe] :FREQuency:CARRier:TRACk:INTerval <value>`

`[:SENSe] :FREQuency:CARRier:TRACk:INTerval?`

Specifies how often the analyzer retunes to a drifting carrier signal. If signal tracking is On and Tracking Mode is set to Interval or to Both, this value specifies the number of individual phase noise measurements that will be made before the analyzer retunes to the carrier signal.

Factory Preset: 10

Range: 1 to 100

Remarks: Only available when signal tracking is On, the Spot Frequency measurement is running and Tracking Mode is set to Interval or to Both.

Front Panel

Access: **FREQUENCY/Channel**

Signal Tracking Mode

```
[ :SENSe] :FREQuency:CARRier:TRACk:METHod  
INTerval | TOLerance | BOTH
```

```
[ :SENSe] :FREQuency:CARRier:TRACk:METHod?
```

Specifies how signal tracking operates. When Tracking Method is set to Interval, the carrier frequency is checked every INTERVAL number of measurements. When Tracking Method is set to Tolerance, the carrier frequency is checked whenever the most recent phase error measurement deviates from the average measurement by TOLERANCE dBc/Hz. The two modes can be combined by specifying BOTH. In this case, retuning occurs either when INTERVAL measurements have been made or when a measurement deviates from the average by TOLERANCE dBc/Hz, depending on which happens first.

Factory Preset: Tolerance

Range: Interval | Tolerance | Both

Remarks: Only available when signal tracking is On and the Spot Frequency measurement is running.

Front Panel

Access: FREQUENCY/Channel, Tracking

Signal Tracking Tolerance

```
[ :SENSe] :FREQuency:CARRier:TRACk:TOLerance <value>
```

```
[ :SENSe] :FREQuency:CARRier:TRACk:TOLerance?
```

Specifies when the analyzer retunes to a drifting carrier signal. If signal tracking is On and Tracking Mode is set to Tolerance or to Both, the analyzer retunes to the carrier wave every time a measurement is made that differs from the previous measurement by TOLERANCE dBc/Hz.

Factory Preset: 10 dBc/Hz

Range: 0 dBc/Hz to 40 dBc/Hz

Remarks: Only available when signal tracking is On, the Spot Frequency measurement is running and Tracking Mode is set to Tolerance or to Both.

Front Panel

Access: FREQUENCY/Channel, Tracking

Phase Noise Log Plot Measurements

Commands for querying the log plot measurement results and for setting to the default values are found in the “[MEASure Group of Commands](#)” on page 115. The equivalent front panel keys for the parameters described in the following commands are found under the **Meas Setup** key when the **Log Plot** measurement has been selected from the **MEASURE** key menu.

Log Plot Number of Averages

```
[ :SENSe ] :LPLot:AVERAge:COUNT <integer>
```

```
[ :SENSe ] :LPLot:AVERAge:COUNT?
```

Specifies the number of measurements made when calculating the average result.

Factory Preset: 10

Range: 1 to 1000

Remarks: You must be in the Phase Noise mode to use this command. Use analyzer:SElect to set the mode.

Front Panel

Access: **Meas Setup**

Log Plot Average State

```
[ :SENSe ] :LPLot:AVERAge: [ :STATe ] ON|OFF|1|0
```

```
[ :SENSe ] :LPLot:AVERAge [ :STATe ] ?
```

Switches averaging on or off.

Factory Preset: Off (Front panel preset)

On (:CONFigure via SCPI)

Remarks: You must be in the Phase Noise mode to use this command. Use analyzer:SElect to set the mode.

Front Panel

Access: **Meas Setup**

Log Plot Averaging Mode Termination Control

```
[ :SENSe ] :LPLot:AVERAge:TCONtrol?
```

Queries and returns the type of termination control used for the averaging function. This determines the averaging action after the specified number of acquisitions (average count) is reached.

REPeat - After reaching the average count, the averaging is reset and a new average is started.

Factory Preset: REPeat

Remarks: The Average Mode will always be set to Repeat.

Log Plot Resolution Bandwidth

```
[ :SENSe ] :LPLot :BANDwidth | BWIDth [ :RESolution ] ?
```

Queries and returns the resolution bandwidth.

Default Unit: Hz

Front Panel

Access: BW/Avg, Res BW

Log Plot Video Bandwidth

```
[ :SENSe ] :LPLot :BANDwidth | BWIDth :VIDeo ?
```

Queries the video bandwidth.

Default Unit: Hz

Front Panel

Access: BW/Avg, Video BW

Log Plot Video to Resolution Bandwidth Ratio

```
[ :SENSe ] :LPLot :BANDwidth | BWIDth :VIDeo :RATio <numeric>
```

```
[ :SENSe ] :LPLot :BANDwidth | BWIDth :VIDeo :RATio ?
```

Specifies the ratio of the video bandwidth to the resolution bandwidth.

Factory Preset: 1.0

Range: 0.001 to 10

Front Panel

Access: BW/Avg, VBW/RBW

DANL Cancellation Delta Threshold

```
[ :SENSe ] :LPLot :CANCellation :DELTA <dB>
```

```
[ :SENSe ] :LPLot :CANCellation :DELTA ?
```

You can specify a minimum difference that must exist between the DANL reference trace and the current measurement before any

cancellation will be performed. This command allows you to specify that minimum value.

Range: 0.001 dB - 5 dB

Example: `LPLot:CANC:DELT 2`

Remarks: The cancellation delta is applied on an individual point by point basis.

Front Panel

Access: **Meas Setup, More, Cancellation**

DANL Cancellation On/Off

```
[ :SENSe ] :LPLot :CANCellation [ :STATe ] OFF | ON | 0 | 1
```

```
[ :SENSe ] :LPLot :CANCellation [ :STATe ] ?
```

This allows you to switch the noise cancellation feature on or off. The cancellation feature allows a previously made measurement of the instrument's DANL noise floor to be automatically subtracted from the current measurement.

Example: `LPLot:CANC ON`

Remarks: The DANL of the instrument must first be measured and stored in a reference trace before the cancellation feature can be used.

Front Panel

Access: **Meas Setup, More 1 of 2, Cancellation**

DANL Cancellation Reference Trace

```
[ :SENSe ] :LPLot :CANCellation :TRACe <tracenum>
```

```
[ :SENSe ] :LPLot :CANCellation :TRACe ?
```

This allows you to change the trace that is used to store the DANL noise floor reference data for use in the DANL cancellation feature.

Range: 1 - 3

Example: `LPLot:CANC:TRAC 2`

Remarks: This reference trace must be in View mode and must cover the same frequency range as that being measured.

Front Panel

Access: **Meas Setup, More, Cancellation**

Log Plot Type of Detection

`[:SENSE] :LPLot:DETECTOR [:FUNCTION] ?`

Queries and returns the detection mode.

Front Panel

Access: **Det/Demod, Detector**

Log Plot Diagnostic of Y-axis Reference Level

`[:SENSE] :LPLot:DIAG:GRAPH:Y:REFERENCE <level>`

`[:SENSE] :LPLot:DIAG:GRAPH:Y:REFERENCE?`

Sets and queries the Y-axis reference level.

Note that diagnostic commands may be changed suddenly, without notification.

Default Unit: dBc/Hz

Example: `LPL:DIAG:GRAP:Y:REF -50`

Front Panel

Access: **Amplitude**

Log Plot Filtering

`[:SENSE] :LPLot:FILTering:NONE | LITtle | MEDium | MAXimum`

This sets the video bandwidth/resolution bandwidth to one of four predetermined values (1.0, 0.3, 0.1 and 0.03).

Factory Preset: None (VBW/RBW ratio = 1.000)

Remarks: You cannot query this command. To find out the current setting, query the VBW/RBW parameter. See [“Log Plot Video Bandwidth”](#) on page 133.

Front Panel

Access: **Meas Setup, Filtering**

Log Plot Start Offset

`[:SENSE] :LPLot:FREQuency:OFFSet:START <freq>`

`[:SENSE] :LPLot:FREQuency:OFFSet:START?`

Specifies the frequency offset at which the measurement starts. The frequency is measured relative to the carrier signal, and refers only to the upper sideband.

Factory Preset: ESA - 10 kHz without Option 1DR

ESA - 100 Hz with Option 1DR

PSA - 100 Hz

Range: 10 times smallest **RBW** to 1 decade less than **Stop Offset**

Remarks: You must be in the Phase Noise mode to use this command. Use analyzer:SElect to set the mode.

Front Panel

Access: **Span/X Scale**

Log Plot Stop Offset

```
[ :SENSe ] :LPLot:FREQuency:OFFSet:STOP <freq>
```

```
[ :SENSe ] :LPLot:FREQuency:OFFSet:STOP?
```

Specifies the frequency offset at which the measurement stops. The frequency is measured relative to the carrier signal, and refers only to the upper sideband.

Factory Preset: 1 MHz

Range: 1 decade greater than **Start Offset** to nine decades greater than **Start Offset** (but limited by analyzer's range).

Remarks: You must be in the Phase Noise mode to use this command. Use analyzer:SElect to set the mode.

Front Panel

Access: **Span/X Scale**

Log Plot Span to Resolution Bandwidth Ratio

```
[ :SENSe ] :LPLot:FREQuency:SPAN:BANDwidth|BWIDth[:RESolution]  
:RATio <numeric>
```

```
[ :SENSe ] :LPLot:FREQuency:SPAN:BANDwidth|BWIDth[:RESolution]  
:RATio?
```

PSA Command only. Specifies the ratio of the span to the resolution bandwidth.

Factory Preset: 106

Range: 2 to 1000

Front Panel

Access: **BW/Avg, Span/RBW**

Log Plot Span to Resolution Bandwidth Ratio Mode

```
[ :SENSe ] :LPLot:FREQuency:SPAN:BANDwidth|BWIDth[:RESolution]
:RATio:AUTO ON|OFF|1|0
```

```
[ :SENSe ] :LPLot:FREQuency:SPAN:BANDwidth|BWIDth[:RESolution]
:RATio:AUTO?
```

PSA Command only. Specifies whether the ratio of the span to the resolution bandwidth is set automatically.

Factory Preset: Auto

Remarks: When set to On or 1, the front panel will display 'Auto'.
 When set to Off or 0, the front panel will display 'Man'.

Front Panel

Access: **BW/Avg, Span/RBW**

Log Plot Measurement Type

```
[ :SENSe ] :LPLot:METHod DANL|PN
```

```
[ :SENSe ] :LPLot:METHod?
```

Determines whether you are measuring the phase noise of a signal or the noise floor (DANL) of the analyzer. Measuring the phase noise of a signal is the default, and is the intended use of the measurement. However, it can be useful to measure the noise floor of the analyzer so that you can compensate for this in your measurement. See [“\[:SENSe\]:DANL:METHod ATTenuator|REMOval” on page 127](#) for more details on the two different types of noise floor measurement.

Factory Preset: PN

Remarks: When measuring the phase noise of a signal, some of the measured phase noise is due to thermal noise generated by the analyzer itself. By measuring the analyzer's internal noise, it can be compensated for, thus giving more accurate results.

You must be in the Phase Noise mode to use this command. Use analyzer:SElect to set the mode.

Front Panel

Access: **Meas Setup**

Log Plot Smooth Trace

```
[ :SENSe ] :LPLot:SMOoth <percentage>
```

```
[ :SENSe ] :LPLot:SMOoth?
```

Specifies the amount of smoothing that is done after the measurement has been completed. The smoothing function is a lot faster than filtering, but it can cause errors if the noise changes rapidly with respect to frequency for example when there are discrete signals present, such as harmonic spurs.

Factory Preset: 4%

Range: 0% to 16%

Remarks: Changing the Smooth Trace parameter forces the smooth trace to be recalculated. This forces all results to be recalculated. There is therefore no need to perform a full restart.

You must be in the Phase Noise mode to use this command. Use analyzer:SElect to set the mode.

Front Panel

Access: **Meas Setup**

Monitor Band/Channel Measurement

Commands for querying the monitor band/channel measurement results and for setting to the default values are found in the “[MEASure Group of Commands](#)” on page 115. The equivalent front panel keys for the parameters described in the following commands, are found under the **Meas Setup** key, after the **Monitor Band/Channel** measurement has been selected from the **MEASURE** key menu.

Monitor Band/Channel—Average Count

```
[ :SENSe ] :MONitor :AVERage :COUNT <integer>
```

```
[ :SENSe ] :MONitor :AVERage :COUNT ?
```

Set the number of data acquisitions that will be averaged. After the specified number of average counts, the averaging mode (terminal control) setting determines the averaging action.

Factory Preset: 10

Range: 1 to 1,000

Remarks: For ESA: You must be in the Bluetooth, cdmaOne, GSM or Phase Noise mode to use this command. Use analyzer:SElect to set the mode.

For PSA: You must be in the Phase Noise mode to use this command. Use analyzer:SElect to set the mode.

Front Panel

Access: **Meas Setup, Avg Number**

Monitor Band/Channel—Averaging State

```
[ :SENSe ] :MONitor :AVERage [ :STATe ] OFF | ON | 0 | 1
```

```
[ :SENSe ] :MONitor :AVERage [ :STATe ] ?
```

Turn averaging on or off.

Factory Preset: On for GSM, Bluetooth.

Off for cdmaOne and Phase Noise.

Remarks: For ESA: You must be in the Bluetooth, cdmaOne, GSM or Phase Noise mode to use this command. Use analyzer:SElect to set the mode.

For PSA: You must be in the Phase Noise mode to use this command. Use analyzer:SElect to set the mode.

Front Panel

Access: **Meas Setup, Avg Number**

Monitor Band/Channel—Averaging Termination Control

```
[ :SENSe ] :MONitor:AVERage:TCONtrol EXPonential | REPeat
```

```
[ :SENSe ] :MONitor:AVERage:TCONtrol?
```

Select the type of termination control used for the averaging function. This determines the averaging action after the specified number of data acquisitions (average count) is reached.

Exponential - After the average count is reached, each successive data acquisition is exponentially weighted and combined with the existing average.

Repeat - After reaching the average count, the averaging is reset and a new average is started.

Factory Preset: Exponential

Remarks: For ESA: You must be in the Bluetooth, cdmaOne, GSM or Phase Noise mode to use this command. Use analyzer:SElect to set the mode.

For PSA: You must be in the Phase Noise mode to use this command. Use analyzer:SElect to set the mode.

Front Panel

Access: Meas Setup, Avg Mode

Monitor Band/Channel—Frequency Span

```
[ :SENSe ] :MONitor:FREQuency:SPAN <freq>
```

```
[ :SENSe ] :MONitor:FREQuency:SPAN?
```

Set the frequency span. Setting the span to 0 Hz puts the analyzer into zero span.

NOTE

In ESA analyzers only, the maximum span is limited to 5 MHz whenever the resolution bandwidth is set to a value of less than 1 kHz. This limitation does not apply to PSA analyzers.

Factory Preset: ESA E4401B: 1.5 GHz

ESA E4402B: 3.0 GHz

ESA E4404B: 6.7 GHz

ESA E4405B: 13.2 GHz

ESA E4407B: 26.5 GHz

PSA E4443A: 6.78 GHz

PSA E4445A: 13.3 GHz

PSA E4440A: 27.0 GHz

Range: ESA E4401B: 100 Hz to 1.58 GHz
 ESA E4402B: 100 Hz to 3.10 GHz
 ESA E4404B: 100 Hz to 6.78 GHz
 ESA E4405B: 100 Hz to 13.3 GHz
 ESA E4407B: 100 Hz to 27.0 GHz
 PSA E4443A: 3 Hz to 6.78 GHz
 PSA E4445A: 3 Hz to 13.3 GHz
 PSA E4440A: 3 Hz to 27.0 GHz

Default Unit: Hz

Front Panel
Access: **SPAN/X Scale, Span**
 or **SPAN/X Scale, Zero Span**

Monitor Band/Channel—Full Frequency Span

`[:SENSe] :MONitor :FREQuency :SPAN :FULL`

Set the frequency span to full scale.

NOTE

In ESA analyzers only, the maximum span is limited to 5 MHz whenever the resolution bandwidth is set to a value of less than 1 kHz. This limitation does not apply to PSA analyzers.

Factory Preset: ESA E4401B: 1.5 GHz
 ESA E4402B: 3.0 GHz
 ESA E4404B: 6.7 GHz
 ESA E4405B: 13.2 GHz
 ESA E4407B: 26.5 GHz
 PSA E4443A: 6.78 GHz
 PSA E4445A: 13.3 GHz
 PSA E4440A: 27.0 GHz

Front Panel
Access: **SPAN/X Scale, Full Span**

Monitor Band/Channel—Zero Frequency Span

[:SENSe] :MONitor :FREQuency :SPAN :ZERO

Set the frequency span to zero.

NOTE

In ESA analyzers only, the maximum span is limited to 5 MHz whenever the resolution bandwidth is set to a value of less than 1 kHz. This limitation does not apply to PSA analyzers.

Factory Preset: ESA E4401B: 1.5 GHz

ESA E4402B: 3.0 GHz

ESA E4404B: 6.7 GHz

ESA E4405B: 13.2 GHz

ESA E4407B: 26.5 GHz

PSA E4443A: 6.78 GHz

PSA E4445A: 13.3 GHz

PSA E4440A: 27.0 GHz

Front Panel

Access: **SPAN/X Scale, Zero Span**

Monitor Band/Channel—Trace Points

[:SENSe] :MONitor :SWEep :POINTs?

Allows you to query the number of trace points.

Factory Preset: 601

Range: Always 601

Front Panel

Access: **Sweep**

Monitor Band/Channel—Sweep Time

[:SENSe] :MONitor :SWEep :TIME <value>

[:SENSe] :MONitor :SWEep :TIME?

Specifies the sweep time of the measurement.

Factory Preset: 14.6 ms (automatically calculated)

Range: *PSA only*: 1 ms to 6 ksecs

ESA only: 4 ms to 4 ksecs

Front Panel
Access: Sweep

Monitor Band/Channel—Time Mode

`[:SENSe] :MONitor :SWEep :TIME :AUTO ON | OFF | 1 | 0`

`[:SENSe] :MONitor :SWEep :TIME :AUTO ?`

Specifies whether the sweep time is set automatically or manually.

Factory Preset: Auto

Remarks: If set to **AUTO**, the sweep time will be affected by the RBW setting.

Front Panel
Access: Sweep

RF Power Commands

RF Mixer Maximum Power

`[:SENSe] :POWER [:RF] :MIXer :RANGe [:UPPer] <power>`

`[:SENSe] :POWER [:RF] :MIXer :RANGe [:UPPer] ?`

Specifies the maximum power at the input mixer.

Factory Preset: 4 dBm

Range: -100 dBm to 10 dBm

Default Unit: dBm

Front Panel
Access: Input/Output, Advanced, Max Mixer Lvl [PSA]

Spot Frequency Measurements

Commands for querying the spot frequency measurement results and for setting to the default values are found in the “[MEASure Group of Commands](#)” on page 115. The equivalent front panel keys for the parameters described in the following commands, are found under the **Meas Setup** key, after the **Spot Frequency** measurement has been selected from the **MEASURE** key menu.

Spot Frequency Number of Averages

```
[ :SENSe ] :SFRequency:AVERAge:COUNT <integer>
```

```
[ :SENSe ] :SFRequency:AVERAge:COUNT?
```

Specifies the number of measurements made when calculating the average result.

Factory Preset: 10

Range: 1 to 1000

Remarks: You must be in the Phase Noise mode to use this command. Use analyzer:SElect to set the mode.

Front Panel

Access: **Meas Setup**

Spot Frequency Average State

```
[ :SENSe ] :SFRequency:AVERAge [ :STATe ] ON|OFF|1|0
```

```
[ :SENSe ] :SFRequency:AVERAge [ :STATe ] ?
```

Switches averaging On or Off.

Factory Preset: Off

Remarks: You must be in the Phase Noise mode to use this command. Use analyzer:SElect to set the mode.

Front Panel

Access: **Meas Setup**

Spot Frequency Averaging Mode Termination Control

```
[ :SENSe ] :SFRequency:AVERAge:TCONtrol EXPonential|REPeat
```

```
[ :SENSe ] :SFRequency:AVERAge:TCONtrol?
```

Select the type of termination control used for the averaging function. This determines the averaging action after the specified number of acquisitions (average count) is reached.

Exponential - Each successive data acquisition after the average count is reached, is exponentially weighted and combined with the existing average.

Repeat - After reaching the average count, the averaging is reset and a new average is started.

Factory Preset: Exponential

Remarks: You must be in the Phase Noise mode to use this command. Use analyzer:SElect to set the mode.

Front Panel

Access: Meas Setup

Spot Frequency Resolution Bandwidth

[:SENSe] :SFrequency: BANDwidth | BWIDth [:RESolution] ?

Queries and returns the resolution bandwidth.

Front Panel

Access: BW/Avg, Res BW

Spot Frequency Resolution Bandwidth Automatic

[:SENSe] :SFrequency: BANDwidth | BWIDth [:RESolution] :AUTO?

Queries the resolution bandwidth mode. This is only available in the Monitor Spectrum measurement.

Front Panel

Access: BW/Avg, Res BW

Spot Frequency Video Bandwidth

[:SENSe] :SFrequency: BANDwidth | BWIDth: VIDEO?

Queries the video bandwidth.

Front Panel

Access: BW/Avg, Video BW

Spot Frequency Video Bandwidth Automatic

[:SENSe] :SFrequency: BANDwidth | BWIDth: VIDEO: AUTO?

Queries the video bandwidth mode.

Remarks: This command is not available in Spot Frequency and

Log Plot measurements, and the soft key is grayed out.

Front Panel

Access: **BW/Avg, Video BW**

Spot Frequency Video to Resolution Bandwidth Ratio

```
[ :SENSe ] :SFRequency:BA NDwidth|BWIDth:VIDeo:RATio <numeric>
```

```
[ :SENSe ] :SFRequency:BA NDwidth|BWIDth:VIDeo:RATio?
```

Specifies the ratio of the video bandwidth to the resolution bandwidth.

Factory Preset: 1.0

Range: 0.001 to 10

Front Panel

Access: **BW/Avg, VBW/RBW**

Spot Frequency Type of Detection

```
[ :SENSe ] :SFRequency:DETEctor [ :FUNCTio n ] ?
```

Queries and returns the detection mode.

Factory Preset: Average

Front Panel

Access: **Det/Demod, Detector**

Spot Frequency Measurement Type

```
[ :SENSe ] :SFRequency:METhod DANL|PN
```

```
[ :SENSe ] :SFRequency:METhod?
```

Determines whether you are measuring the phase noise of a signal or the noise floor of the analyzer itself. The noise floor is referred to as DANL (displayed average noise level). Measuring the phase noise of a signal is the default, and is the intended use of the measurement. However, if your phase noise level is low, it can be useful to measure the noise floor of the analyzer so that you can compensate for this in your measurement. See “[:SENSe]:DANL:METhod ATTenuator | REMoval” on page 127 for more details on the two different types of noise floor measurement.

Factory Preset: Phase Noise

Remarks: You must be in the Phase Noise mode to use this command. Use analyzer:SElect to set the mode.

Front Panel

Access: **Meas Setup, Meas Type**

Spot Frequency Phase Noise Optimization

PSA analyzers only

```
[ :SENSe] :SFrequency:PNOFrequency <freq>
```

```
[ :SENSe] :SFrequency:PNOFrequency?
```

The PSA spectrum analyzer has two different filters which it can use to measure the phase noise. One filter is better suited to phase noise at small offsets, and the other is better suited to larger offsets. Use this command to specify the cross-over point from one filter to the other.

Factory Preset: 45 kHz

Range: 40 kHz to 60 kHz

Remarks: This is only valid on the PSA series spectrum analyzers.

If you are measuring phase noise at a frequency offset between 40 kHz and 60 kHz, you can make one measurement with :PNOFrequency greater than your measurement's offset and one with :PNOFrequency smaller. The lower of the two phase noise figures is the more accurate.

You must be in the Phase Noise mode to use this command. Use analyzer:SElect to set the mode.

Front Panel

Access: Meas Setup, Advanced, PhNoise opt f

Spot Frequency Phase Noise Optimization Mode

PSA analyzers only

```
[ :SENSe] :SFrequency:PNOFrequency:AUTO ON|OFF|1|0
```

```
[ :SENSe] :SFrequency:PNOFrequency:AUTO?
```

The PSA spectrum analyzer has two different filters which it can use to measure the phase noise. One filter is better suited to phase noise at small offsets, and the other is better suited to larger offsets. This command specifies whether the crossover point from one filter to the other is controlled automatically or is under manual control.

Factory Preset: On

Remarks: This is only valid on the PSA series spectrum analyzers.

You must be in the Phase Noise mode to use this

command. Use analyzer:SElect to set the mode.

Remarks:

Front Panel

Access: Meas Setup, Advanced, PhNoise opt f

Spot Frequency Offset

```
[ :SENSe ] :SFRrequency:SOFFset <value>
```

```
[ :SENSe ] :SFRrequency:SOFFset?
```

Specifies the frequency offset at which the phase noise is to be measured.

Factory Preset: 10 kHz

Range: *PSA series:* 100 Hz to 100 MHz

ESA series with Opt. 1DR: 100 Hz to 100 MHz

ESA series without Opt. 1DR: 10 kHz to 100 MHz

Remarks: You must be in the Phase Noise mode to use this command. Use analyzer:SElect to set the mode.

Front Panel

Access: FREQUENCY/Channel, Tracking, Tolerance

Resolution Bandwidth/Spot Frequency Offset Percent

```
[ :SENSe ] :SFRrequency:SOFFset:BANDwidth|BWIDth[:RESolution]  
:RATio <value>
```

```
[ :SENSe ] :SFRrequency:SOFFset:BANDwidth|BWIDth[:RESolution]  
:RATio?
```

The Resolution Bandwidth is specified as a percentage of the offset frequency. This command allows you to specify this percentage value.

Factory Preset: 10

Range: 1 to 30

Remarks: You must be in the Phase Noise mode to use this command. Use analyzer:SElect to set the mode.

Front Panel

Access: Meas Setup, more, Advanced, RBW/Spot Offset %

Spot Frequency Sweep Time

```
[ :SENSe ] :SFRrequency:SWEep:TIME <value>
```

`[:SENSe] :SFrequency :SWEep :TIME?`

Specifies the sweep time of the measurement.

Factory Preset: 5 ms

Range: 1 ms to 1 s

Remarks: You must be in the Phase Noise mode to use this command. Use analyzer:SElect to set the mode.

Front Panel

Access: Sweep

Spot Frequency Sweep Time Mode

`[:SENSe] :SFrequency :SWEep :TIME :AUTO ON | OFF | 1 | 0`

`[:SENSe] :SFrequency :SWEep :TIME :AUTO?`

Specifies whether the sweep time is set automatically or manually.

Factory Preset: Auto

Remarks: You must be in the Phase Noise mode to use this command. Use analyzer:SElect to set the mode.

Front Panel

Access: Sweep

6 **If You Have A Problem**

Agilent Customer Assistance

By internet, phone, or fax, get assistance with all your test and measurement needs.

Table 6-1 **Contacting Agilent**

Online assistance: <http://www.agilent.com/find/assist>

United States (tel) 1 800 452 4844	Latin America (tel) (305) 269 7500 (fax) (305) 269 7599	Canada (tel) 1 877 894 4414 (fax) (905) 282-6495	Europe (tel) (+31) 20 547 2323 (fax) (+31) 20 547 2390
New Zealand (tel) 0 800 738 378 (fax) (+64) 4 495 8950	Japan (tel) (+81) 426 56 7832 (fax) (+81) 426 56 7840	Australia (tel) 1 800 629 485 (fax) (+61) 3 9210 5947	

Asia Call Center Numbers

Country	Phone Number	Fax Number
Singapore	1-800-375-8100	(65) 836-0252
Malaysia	1-800-828-848	1-800-801664
Philippines	(632) 8426802 1-800-16510170 (PLDT Subscriber Only)	(632) 8426809 1-800-16510288 (PLDT Subscriber Only)
Thailand	(088) 226-008 (outside Bangkok) (662) 661-3999 (within Bangkok)	(66) 1-661-3714
Hong Kong	800-930-871	(852) 2506 9233
Taiwan	0800-047-866	(886) 2 25456723
People's Republic of China	800-810-0189 (preferred) 10800-650-0021	10800-650-0121
India	1-600-11-2929	000-800-650-1101

A

active license key, 23
 how to locate, 23
 advanced functions
 Meas Setup, 88
 Agilent Technologies URL, 2
 Amplitude menu map, 47, 48, 49
 AMPLITUDE Y Scale
 Delta Freq, 77
 front-panel key, 77
 Phase Noise, 77
 Ref Position, 77
 Ref Value, 77
 AMPLITUDE Y Scale menu, 47,
 48, 49
 Annotation
 Display, 80
 applications, selecting, 111, 112
 ASCII data format, 109
 average
 counts, 144
 spot frequency, 144
 average count
 log plot, 132
 average mode, 87
 Averages
 viewing, 80
 averaging, 31
 log plot, 132
 monitor band/channel, 139, 140
 spot frequency, 144
 Avg Mode key, 87
 Avg Number
 Meas Setup, 87

B

bandwidth
 resolution BW, 145
 setting resolution BW, 133, 145
 setting video BW, 133, 145
 span ratio, 136, 137
 video BW, 145
 video BW ratio, 133, 146
 begin measurement, 110
 blank trace, 96
 both
 tracking mode, 82

C

cancellation
 Meas Setup, 89
 reference trace, 89
 threshold, 89
 cancellation on log plot
 measurements, 34
 Carrier Freq key, 81

Carrier Search, 81
 carrier search
 search span, 81
 carrier signal
 tracking drift, 129, 130, 131
 carrier signal frequency, 128
 carrier signal search, 128, 129
 carrier signal search span, 129
 changing
 instrument settings, 126
 Channel menu map, 54, 55
 characteristics, 16
 Choose Option key, 23
 commands
 CONFigure, 116
 FETCh, 117
 MEASure, 115
 READ, 117
 compatibility, 16
 CONFigure command use, 115
 CONFigure commands, 116
 continuous measurement, 95
 continuous sweep, 95
 copy trace
 log plot, 101
 copying the utility to memory, 18,
 20
 current measurement, 106

D

DANL, 127
 measuring, 83
 spot frequency, 146
 DANL cancellation, 134
 delta, 133
 DANL floor
 log plot, 34
 DANL floor noise measurement,
 87
 DANL floor reference
 example measurement, 37
 DANL measurement, 137
 DANL method, 83
 attenuation, 83
 removal, 83
 DANL noise
 measuring, 83
 data format, 109
 data from measurements, 115
 decade table, 101
 Meas Setup, 89
 default settings
 restoring, 87, 92
 default values, setting remotely,
 116
 defaults, 127
 delta, 84

marker, 103
 Delta Freq
 AMPLITUDE Y Scale, 77
 Ref Value, 77
 Scale/Div, 77
 demodulation functions, 79
 Det/Demod
 front-panel key, 79
 detection mode, 135, 146
 detection type, 135, 146
 disk drive commands, 123
 Display, 80
 Annotation, 80
 front-panel key, 80
 Full Screen, 80
 Graticule, 80
 menu, 80
 Preferences, 80
 Tolerance Limits, 80
 View Avg, 80
 display
 display line, 107
 display average noise level, 127
 display commands, 107
 Display menu map, 50, 51, 52, 53
 drift span, 81
 drifting signals, 33, 129, 130, 131
 tracking, 81, 82

E

equipment required, 16
 example measurement
 DANL floor reference, 37
 noise cancellation, 37, 40
 signal phase noise reference, 40

F

Factory Preset key, 93
 FETCh command use, 115
 FETCh commands, 117
 files
 traces, 123, 124
 Filtering
 Little, 88
 Maximum, 89
 Medium, 89
 None, 88
 filtering, 31
 log plot, 135
 Meas Setup, 88
 format, data, 109
 frequency
 carrier search, 128, 129
 carrier search span, 129
 carrier signal, 128
 span, 140, 141, 142
 start offset, 135

Index

- stop offset, 136
- FREQUENCY Channel
 - front-panel key, 81
- FREQUENCY Channel menu
 - map, 54, 55
- frequency error, 84
- frequency span
 - full, 141
 - setting, 140
 - zero, 142
- front-panel key
 - AMPLITUDE Y Scale, 77
 - Det/Demod, 79
 - Display, 80
 - FREQUENCY Channel, 81
 - Input, 83
 - Input/Output, 83
 - Marker, 84
 - Meas Setup, 87
 - MEASURE, 90
 - MODE, 91
 - Mode Setup, 92
 - Preset, 93
 - SPAN X Scale, 94
 - Sweep Menu, 95
 - Trace/View
 - View/Trace. See front panel key
 - Trace/View
- Full Screen
 - Display, 80
- G**
- graphical view, 96
- Graticule
 - Display, 80
- GSM Mode defaults, 127
- I**
- initiate measurement, 110
- Input, 83
 - max mixer level, 83
- Input front-panel key, 83
- Input/Output
 - Advanced, 83
 - Max Mixer Level, 83
 - max mixer level, 83
- input/output, 83
- Input/Output front-panel key, 83
- Install Now key, 23
- Installer menu map, 56, 57
- installing the utility, 18, 20
- instrument configuration, 111
- interval
 - tracking mode, 81, 82
- J**
- jitter
 - noise, 84
- L**
- Little
 - Filtering, 88
- load/save, 97
- loading
 - traces from file, 123
- loading files, 97
- loading trace data, 97
- log plot, 90, 101
 - average count, 132
 - copy trace, 101
 - DANL floor, 34
 - filtering, 135
 - method, 137
 - phase noise, 132
 - resolution bandwidth, 133
 - smooth trace, 138
 - span/rbw ratio, 136, 137
 - start offset, 135
 - stop offset, 136
 - swap traces, 102
 - trace mode, 101
 - video bandwidth, 133
 - video/rbw ratio, 133
- log plot - averaging mode, 132
- log plot measurement, 119, 132
- log plot measurements, 29
- log plot noise cancellation, 35
- M**
- making measurements, 115
- Marker, 84
 - All Off, 86
- marker, 103, 104
 - delta, 84
 - normal, 84
 - off, 84
 - Residual FM, 84
 - RMS noise, 84
 - RMS noise degrees, 84
 - RMS noise jitter, 84
 - RMS noise radians, 84
 - select marker, 84
 - table, 86
 - trace, 85
 - trace number, 104
 - X axis position, 104
 - Y axis position, 104
- Marker front-panel key, 84
- marker table, 103
- markers, 103
- mass storage commands, 123
- Max Mixer Level, 83
- max mixer level
 - input, 83
 - input/output, 83
- Maximum
 - Filtering, 89
- maximum power to mixer, 143
- Meas, 87
- Meas Setup
 - advanced functions, 88
 - Avg Number, 87
 - cancellation, 89
 - decade table, 89
 - filtering, 88
 - Meas Type, 87
 - Monitor Spectrum, 60, 61, 62
 - PhNoise Opt f, 88
 - RBW/spot offset, 88
 - reference trace, 89
 - Restore Meas Defaults, 87
 - smoothing, 88
 - spot offset, 87
 - table index, 88
 - threshold, 89
- Meas Setup front-panel key, 87
- Meas Type
 - Meas Setup, 87
- meas type
 - DANL floor, 87
 - phase noise, 87
- measure, 90
- MEASure command use, 115
- MEASure commands, 115
- MEASURE front-panel key, 90
- MEASURE menu map, 58, 59
- measurement, 90
 - initiate, 110
 - log plot, 132
 - query current, 106
 - spot frequency, 144
- measurement format, 109
- measurement modes
 - selecting, 111, 112
- measurement points, 95
- measurements
 - CONF/FETC/MEAS/READ
 - commands, 115
 - getting results, 115
 - log plot, 119
 - monitor band/channel, 121, 139
 - setting default values remotely, 116
 - spot frequency, 122
- Medium
 - Filtering, 89
- memory commands, 123
- menu map

- Amplitude, 47, 48, 49
- Channel, 54, 55
- Display, 50, 51, 52, 53
- FREQUENCY Channel, 54, 55
- Installer, 56, 57
- MEASURE, 58, 59
- Mode Setup, 64
- Monitor Spectrum, 60, 61, 62
- Noise Cal, 63
- SPAN X Scale, 65, 66, 67
- Sweep, 68, 69
- Trace, 71, 72, 73
- Trig, 70
- View/Trace, 71, 72, 73
- method
 - log plot, 137
 - spot frequency, 146
- mixer
 - maximum input power, 143
- mixer level
 - maximum, 83
- mode
 - phase noise, 91
- MODE front-panel key, 91
- Mode Preset key, 93
- Mode Setup
 - Restore Mode Setup Defaults, 92
- mode setup
 - properties, 92
- Mode Setup front-panel key, 92
- Mode Setup menu map, 64
- monitor
 - sweep time, 142, 143
 - trace points, 142
- monitor band/channel - average count, 139
- monitor band/channel - averaging state, 139
- monitor band/channel - averaging termination control, 140
- monitor band/channel measurement, 121, 139
- monitor band/channel
 - See also MON
- Monitor Spectrum, 90
 - Meas Setup, 60, 61, 62
 - menu map, 60, 61, 62
- moving data between traces, 96
- N**
- noise
 - measuring, 83
- Noise Cal menu map, 63
- Noise cancellation
 - example measurement, 35, 37, 40
- noise cancellation, 134
 - delta, 133
 - example measurement, 37, 40
 - log plot, 35
- noise floor
 - checking, 33
- noise jitter, 84
- None
 - Filtering, 88
- normal, 84
- numerical view, 96
- O**
- offset
 - spot frequency, 148
- offset start
 - log plot, 135
- offset stop
 - log plot, 136
- operations on traces, 96
- optimization
 - spot frequency, 147
- P**
- performance specifications, 16
- personalities
 - selecting, 111, 112
- Phase Noise
 - AMPLITUDE Y Scale, 77
 - Ref Value, 77
- phase noise
 - degrees, 103
 - frequency, 103
 - jitter, 103
 - log plot, 132
 - radians, 103
 - spot frequency, 144
- phase noise cancellation, 89
- phase noise measurement, 87, 119, 122
- phase noise measurement information, 44
- phase noise mode, 91
- PhNoise Opt f
 - Meas Setup, 88
- points
 - sweep, 95
- position
 - marker, 103, 104
- Preferences
 - Display, 80
- preset
 - factory, 93
 - mode, 93
 - user, 93
- Preset front-panel key, 93
- properties
 - mode setup, 92
- R**
- raw trace, 96
- RBW, 148
- RBW/spot offset
 - Meas Setup, 88
- READ command use, 115
- READ commands, 117
- real number data format, 109
- Ref Position
 - AMPLITUDE Y Scale, 77
- Ref Value
 - AMPLITUDE Y Scale, 77
 - Delta Freq, 77
 - Phase Noise, 77
- Ref Value key
 - remote command, 135
- Reference (View) trace, 96
- reference level
 - log plot measurement, 135
- reference trace
 - cancellation, 89
 - DANL floor, 37
 - Meas Setup, 89
 - signal phase noise, 40
- Residual FM, 84
- Resolution Bandwidth, 148
- resolution bandwidth
 - log plot, 133
 - on/off, 145
 - setting, 133, 145
 - spot frequency, 145
- Restore Meas Defaults
 - Meas Setup, 87
- Restore Mode Setup Defaults
 - Mode Setup, 92
- results format, 109
- RMS noise, 84
- RMS noise degrees, 84
- RMS noise jitter, 84
- RMS noise radians, 84
- RMS phase noise, 29
- S**
- sample measurement
 - DANL floor reference, 37
 - noise cancellation, 37, 40
 - signal phase noise reference, 40
- saving files, 97
- saving trace data, 97
- Scale/Div
 - Delta Freq, 77
- search
 - carrier signal, 128, 129
- Search Span, 81
- search span

Index

- carrier signal, 129
 - See “Log Plot Video Bandwidth”
 - on page 658., 135
 - select marker, 84
 - SENSe defaults, 127
 - setting
 - Avg Mode, 87
 - carrier frequency, 81
 - carrier search, 81
 - signal phase noise reference
 - example measurement, 40
 - Signal tracking, 81
 - Signal tracking mode, 82
 - both, 82
 - interval, 81, 82
 - tolerance, 82
 - single frequency measurements, 31
 - single measurement, 95
 - single sweep, 95
 - smooth trace
 - log plot, 138
 - smoothed trace, 96
 - smoothing, 31
 - Meas Setup, 88
 - span
 - carrier signal search, 129
 - Span key
 - ref value, 94
 - scale/div, 94
 - start offset, 94
 - stop offset, 94
 - span setting, 140, 141, 142
 - SPAN X Scale front-panel key, 94
 - SPAN X Scale menu map, 65, 66, 67
 - span/resolution bandwidth ratio, 136, 137
 - log plot, 136, 137
 - specifications, 16
 - spectrum, monitor, 90
 - spot frequency, 90
 - average, 144
 - average number of counts, 144
 - DANL, 146
 - method, 146
 - offset, 148
 - optimization, 147
 - phase noise, 144
 - resolution bandwidth, 145
 - sweep time, 149
 - video bandwidth, 145
 - video/rbw ratio, 146
 - spot frequency - averaging mode, 144
 - spot frequency measurement, 122, 144
 - spot frequency measurements, 31
 - spot offset
 - Meas Setup, 87
 - start measurement, 110
 - start offset
 - log plot, 135
 - state
 - changing, 126
 - stop offset
 - log plot, 136
 - storing
 - traces to file, 124
 - swap traces
 - log plot, 102
 - sweep, 95
 - continuous, 95
 - points, 95
 - single, 95
 - Sweep Menu front-panel key, 95
 - Sweep menu map, 68, 69
 - sweep time, 95
 - monitor, 142, 143
 - spot frequency, 149
 - system noise floor, 33
- T**
- table
 - marker, 86
 - Table 7-1 on page 137, 17
 - table index
 - Meas Setup, 88
 - threshold
 - cancellation, 89
 - Meas Setup, 89
 - tolerance
 - tracking drift, 82
 - tracking mode, 82
 - Tolerance Limits
 - Display, 80
 - trace, 85, 96
 - blank, 96
 - marker number, 104
 - Reference (View), 96
 - trace format, 109
 - trace mode
 - log plot, 101
 - trace points
 - monitor, sweep
 - trace points, 142
 - Trace/View front-panel key
 - traces
 - loading from file, 123
 - moving data between, 96
 - storing to file, 124
 - tracking, 129
 - drift span, 130
 - tracking a drifting signal, 129, 130, 131
 - tracking interval, 130
 - tracking mode, 131
 - both, 82
 - interval, 81, 82
 - tolerance, 82
 - tracking signals, 81, 82
 - drift span, 81
 - tolerance, 82
 - tracking tolerance, 131
 - trigger measurement, 110
- U**
- Uninstall Now, 24
 - URL (Agilent Technologies), 2
 - User Preset key, 93
 - using cancellation with log plog
 - measurements, 34
 - using the utility, 29
- V**
- video bandwidth
 - log plot, 133
 - on/off, 145
 - setting, 133, 145
 - spot frequency, 145
 - video/resolution bandwidth ratio, 133, 146
 - log plot, 133
 - spot frequency, 146
 - View averages, 80
 - View Avg
 - Display, 80
 - view commands, 107
 - View/Trace
 - blank trace, 96
 - graphical view, 96
 - load/save, 97
 - numerical view, 96
 - operations, 96
 - raw trace, 96
 - Reference (View) trace, 96
 - smoothed trace, 96
 - trace, 96
 - View/Trace front-panel key. See Trace/View front-panel key
 - View/Trace menu map, 71, 72, 73
- X**
- X axis position
 - marker, 104
- Y**
- Y axis position
 - marker, 104

Z

zero span, [142](#)

Index
